

**Immigration and the U.S. Economy:
Labor-Market Impacts, Illegal Entry, and Policy Choices**

Gordon H. Hanson
UC San Diego and NBER

Kenneth F. Scheve
Yale University

Matthew J. Slaughter
Dartmouth College and NBER

Antonio Spilimbergo
International Monetary Fund

June 2001

The views expressed in this paper are those of the authors and do not necessarily represent those of the IMF or its Board of Directors.

Immigration and the U.S. Economy: Labor-Market Impacts, Illegal Entry, and Policy Choices

Gordon H. Hanson, Kenneth F. Scheve, Matthew J. Slaughter, and Antonio Spilimbergo

Executive Summary

Since the 1960s, the United States has undergone a surge in immigration. The share of the U.S. population that is foreign born surpassed 10% in 2000, with new immigrants accounting for nearly half of recent U.S. population growth. Three policy issues are central to the current debate about immigration. One is what should be the level and composition of legal immigration. The United States admits relatively large numbers of immigrants with low levels of education and other discernible skills. Rising immigration of the less skilled may lower wages of native workers. A second issue is what to do about illegal immigration. Illegal aliens account for one third of new U.S. immigrants. An open question is whether U.S. policy should attempt to replace illegal immigration with large-scale temporary immigration of foreign workers. A third issue is whether immigrants should be eligible for public assistance. Denying eligibility could reduce immigration and lower fiscal transfers from natives to immigrants.

In this paper, we examine immigration in the United States over the last several decades in order to gauge the potential for and the consequences of changes in U.S. immigration policy. Our study has six main sections, following an introduction.

In section 2, we review U.S. immigration policy and trends. Current U.S. policy sets a quota on overall immigration, with first priority for admissions given to family members of U.S. citizens and legal residents. In recent years, fewer than 15% of new immigrants have been admitted based on their skill level. Whether intended or not, this policy favors immigrants with relatively little schooling. Recent immigrants tend to concentrate in specific regions and industries, and tend to earn much less than natives.

In section 3, we consider how U.S. regional economies adjust to immigrant inflows. Despite the geographic concentration of recent immigrants, wages have not fallen perceptibly in the gateway communities in which immigrants settle. Regions have adjusted to immigrant inflows through other mechanisms, including skill upgrading of the native labor force, outmigration of native workers, and shifts in output mix towards immigrant-intensive industries. If education levels of the U.S. labor force stabilize, as they are expected to do, the wage impacts of immigration may be more pronounced.

In section 4, we examine the factors that influence U.S. illegal immigration. Most illegal immigrants enter the country either by crossing the Mexico-U.S. border or by overstaying entry visas. Mexico is the largest source country for illegal immigration and illegal entry tends to surge following economic downturns in the country. The U.S. government impedes illegal immigration by policing borders and monitoring employers, with the vast majority of resources dedicated to border enforcement. These efforts appear to have had limited success, as the inflow of illegal immigrants continues unabated.

In section 5, we examine the fiscal impact of immigration. Prior to U.S. welfare reform in 1996, immigrants were more likely than natives to receive public assistance. New laws restrict immigrant access to many benefits, one important exception being costly public education. For some types of public assistance, individual U.S. states have the discretion to offer benefits after an individual has been in the country for at least five years. Excluding immigrants from public

assistance has been subject to numerous judicial challenges. Despite immigrant use of public assistance, the net fiscal transfer from natives to immigrants appears to be very small at the national level, though it is higher in a few specific states that have both generous welfare benefits and large immigrant populations. In general, the older and the less educated the adult immigrant population is, the larger are native-to-immigrant net fiscal transfers.

In section 6, we examine the political economy of U.S. immigration policy. We find that individual opinions about immigration policy are influenced by expectations about its impact on outcomes in the labor market and on public services and the welfare state. In particular, less-skilled workers and political conservatives are among those most opposed to freer immigration. Congressional representatives seem to respond to these concerns in their districts when voting on legislation.

In section 7, we conclude by discussing current policy choices facing the United States. Key decisions for U.S. policy makers include whether to replace family-based immigration with skills-based immigration, whether to continue to exclude immigrants from access to public assistance, whether to expand temporary immigration, and how to balance border and interior policing in enforcing against illegal immigration.

Policy Recommendations

U.S. immigration policies based on family reunification have been associated with rising immigration of the less skilled. An alternative policy would be to admit immigrants based on their human capital. A shift in immigration policy to favor the admission of young, highly skilled workers might tend to reduce any negative impacts of immigration on low-skilled native workers, enhance the U.S. comparative advantage in knowledge-intensive industries, and generate positive net fiscal transfers from immigrants to natives. The first two effects would operate through labor supply. Increasing the relative supply of more-skilled workers may increase the wages of less-skilled workers, in both relative and real terms. A larger supply of more-skilled labor would also tend to shift the pattern of specialization towards industries that use this factor intensively, including high-technology sectors, finance, and business services. The third effect, of reversing net fiscal transfers from natives to immigrants, reflects the fact that young, highly educated immigrants have had their schooling financed abroad and stand to make U.S. tax contributions over most of their working life. Given their high earnings ability, these individuals are also unlikely to use public assistance.

To the extent U.S. objectives in setting immigration policy are to soften the economic impact on low-skilled natives, strengthen the country's position in knowledge-intensive industries, and avoid fiscal transfers from natives to immigrants, replacing family-based immigration with skills-based immigration is a logical choice. Skills-based immigration might have several important limitations relative to these objectives, however. One is simply that the presumed impacts on less-skilled wages and fiscal transfers might be quite small. A second limitation is that favoring young, highly skilled immigrants may contribute to "brain drain" from poorer countries, which might undermine development prospects in such countries. And a third limitation is that in the long run, the distinction between skills and family-based immigration policies may not be so sharp. Given political pressures from immigrant and civil rights groups and the U.S. tradition of family-based immigration, the United States may find it difficult to admit only skilled individuals and not their less-skilled family members.

To limit fiscal transfers to immigrants, an alternative policy would be to expand laws that directly exclude immigrants from access to public assistance. However, recent U.S. examples

demonstrate that such legislative exclusions are often challenged judicially, with courts limiting these laws. More broadly, there is ongoing discussion as to whether excluding immigrant access to public assistance violates the U.S. Constitution. For instance, the largest transfer most immigrants receive is in the form of public education, to which it is both politically and legally difficult to restrict the access of immigrants—legal or illegal. All this suggests that a more effective means of limiting immigrant fiscal transfers might be the indirect method of admitting immigrants who are likely to make positive net fiscal contributions—e.g., the more-skilled.

A switch from family to skills-based immigration may also alter the behavior of illegal immigrants. Individuals who find themselves cut off from opportunities for legal immigration—such as less-skilled relatives of U.S. residents—may choose to immigrate illegally. This switch may therefore increase attempts at illegal immigration. If the U.S. objective is to not increase illegal immigration, then complementary policies are needed. That said, the recent tide of illegal immigrants into the United States suggest that the overall number of illegals has not been greatly affected by the current U.S. policy mix of heavy border enforcement, light interior enforcement, and low levels of temporary immigration of manual laborers.

To reduce the total inflow of illegals, one policy option might be to increase temporary immigration of manual laborers. This would seek to replace an unregulated, long-run supply of illegal workers with a regulated, short-run supply of legal workers. In theory, large-scale temporary immigration would curtail illegal immigration if U.S. firms viewed illegal workers and temporary legal workers as close substitutes and if potential migrants viewed temporary migration as reasonably comparable to illegal migration. There are reasons to doubt that this latter condition holds. Even if temporary immigration were to succeed in reducing illegal immigration, the question remains of what objective would have been achieved. If temporary immigrants and illegal immigrants translate into roughly the same shift in relative labor supplies, then they will have roughly the same impacts on wages and industry mix. And the impact of the two inflows on fiscal balances may also be roughly similar.

To reduce the total inflow of illegals, a different policy option would be to increase employer monitoring. U.S. law forbids firms from hiring illegal aliens, but enforcement appears to be lax. Demand for illegal labor could be reduced by conducting random, unannounced worksite inspections and by levying much larger fines. In turn, this lower demand might reduce illegal entry. The main obstacle to greater employer monitoring appears to be intense political opposition by employers.

It appears that wide-ranging reform of U.S. immigration policy is unlikely in the near future, thanks to the interaction of various constituencies. But as the process of U.S. welfare reform in the mid-1990s demonstrates, pressure and consensus for large policy changes can build very quickly. Our discussion has aimed to clarify how different immigration policies present different trade-offs across different policy objectives.

1. Introduction

Since the 1960s, the United States has undergone a surge in immigration. The share of the U.S. population that is foreign born reached 10.4% in 2000, up from a 150-year low of 5% in 1970 but still below the 1910 high of 15% (see Figure 1.1). Few other advanced countries have higher foreign-born populations.¹ During the 1990s, an average of one million legal immigrants and 300,000 illegal immigrants entered the United States each year, accounting for 40% of the decade's population growth².

What is surprising about this recent immigration episode is that U.S. immigration policy has *not* become markedly more open. In fact, during this period the United States has liberalized foreign trade and direct investment much more than it has immigration. Cross-border flows of goods, capital, and labor all help eliminate cross-border differences in factor prices. The United States has reduced barriers to trade and investment on many fronts, such as by helping create the World Trade Organization and by enacting the North American Free Trade Agreement. There is no such analogous record on immigration. Instead, in the discussion of how the United States should integrate into the world economy, immigration is the least favored option.

The lack of liberalization in immigration policy does not, however, indicate a policy consensus. Rather, immigration is a sharply contentious issue with substantial political conflict characterizing every aspect of policy debates. Some groups clearly support expanded immigration. Amidst the tight labor markets of the late 1990's, employers complained that restrictive immigration quotas were helping choke off the long-running U.S. expansion. Interestingly, these sort of concerns came from both high-skill and low-skill industries. In 1998, the U.S. Congress temporarily increased the number of work visas allotted to highly-skilled immigrants, thanks largely to intensive lobbying from high-technology companies in Silicon Valley and elsewhere. Claiming that a shortage of manual labor threatens U.S. agriculture, farmers in California, Oregon, Texas, and elsewhere are currently pushing to reinstate large-scale temporary immigration of field workers from Mexico and elsewhere, a program defunct since the 1960s.³ The Mexican government is also lobbying for expanded temporary immigration, to

¹ Among OECD countries in 1997 (excluding Luxembourg), only Australia (21.1%), Canada (17.4%), and Switzerland (19.0%) had foreign-born population shares higher than the United States.

² For the period 1990-2000, growth in the foreign-born population accounted for 33.7% of U.S. population growth. Births to immigrants that arrived in the 1990s accounted for another 6.5% of population growth (Camarota, 2001).

³ Current U.S. policy does allow for the temporary immigration of farm laborers, as discussed in section 4.

remedy what it sees as degrading treatment of Mexican farm workers in the United States, many of whom are illegal aliens.

A diverse set of groups is lined up against freer immigration. Many in favor of tax reform claim that immigrants receive more in public benefits than they contribute to revenue. Labor activists worry that immigration lowers U.S. wages and labor standards. And nativists, such as perennial presidential candidate Pat Buchanan, fear that ongoing immigration from non-European countries weakens the U.S. social fabric.

Three sets of related policy issues are central to the debate about immigration. One is what should be the level and composition of legal immigration. Despite restrictions on immigration, the labor-market magnitude of U.S. immigration is on par with that of international trade. In 1990, there were 11.7 million foreign-born workers in the United States. This compares with the equivalent net inflow of 8.3 million workers arising from the labor-market services embodied in U.S. exports and imports (Davis and Weinstein, 1998).⁴ Immigration on this scale has the potential to alter the structure and growth of U.S. industry. Whether intended or not, current policy appears to favor individuals with relatively low levels of education and other observable skills. Rising immigration of the less skilled may lower wages of less-skilled native workers, shift U.S. comparative advantage, and strain government budgets.

A second policy issue is what to do about illegal immigration. Currently, illegal aliens account for one third of new U.S. immigrants. The U.S. government impedes illegal entry by policing the U.S.-Mexico border, where about half of illegal immigrants enter the United States, and by monitoring likely employers of undocumented workers. It devotes the vast majority of resources to border enforcement, with, at best, mixed success. Proposals to reinstate temporary immigration from Mexico would have the U.S. government begin to regulate, in effect, the current inflow of illegal labor.

A third policy issue is whether immigrants should be eligible for public assistance. Denying eligibility could reduce incentives to emigrate to the United States for the purpose of obtaining government transfers. In recent years, California and other states have passed restrictions on immigrant access to public assistance. While recent U.S. legal decisions have

⁴ The estimated net inflow of foreign workers embodied in U.S. trade is in U.S. productivity-equivalent terms. See Davis and Weinstein (1998) for details.

limited the scope of these laws, the possibility of immigrants gaining at taxpayers' expense remains a politically-charged issue.⁵

Despite widespread dissatisfaction with U.S. immigration practices, the delicate political economy of immigration makes changing policy difficult. Arguable imperfections in the existing system—such as admitting immigrants without consideration of labor-market conditions or foregoing revenue illegal immigrants might pay in return for legal residence—are the outcome of a compromise among the myriad groups favoring and opposing immigration. The relative influence of these groups can change with shocks to the economy or the political system. Rapid economic growth and low unemployment usually strengthen the hand of employers seeking more work visas. Calls for stricter enforcement against illegal immigration are loudest following crashes in the Mexican economy, which lead to more attempts at illegal entry.

In this manuscript, we examine immigration in the United States over the last several decades in order to gauge the potential for and the consequences of changes in U.S. immigration policy.⁶ We aim to elucidate key aspects of the ongoing U.S. debate over immigration policy—with lessons not just for the United States but also for other countries facing rising immigration. Our study has four main sections.

First, to see how immigration affects native workers we consider how regional economies in the United States have adjusted to immigrant inflows. A large body of research finds that the impact of immigration on native wages is very small. We explain how this outcome may occur if regions can adjust to immigration through mechanisms other than wage changes. These include outmigration of native workers, changes in regional imports and exports, or changes in technology. The labor-market impact of immigration depends on which adjustment mechanisms are operative. The recent U.S. experience suggests that wage adjustments need not predominate, but the conditions that have contributed to this outcome may not persist. We identify possible changes in the economic environment, under which the wage impacts of immigration could become more pronounced. The larger is the impact of immigration on wages, the stronger demands for changes in the level or composition of immigration are likely to be.

⁵ As discussed in Section 5, in 1994, California passed proposition 187, which barred children of illegal immigrants from receiving public services (including the right to attend school). It was struck down by a federal court in 1995. In 1996, the U.S. Congress passed legislation to deny eligibility for food stamps, federal disability assistance, and other government benefits to legal immigrants who had not become citizens. These changes did become law, as part of the package of welfare reforms in the Personal Responsibility and Work Opportunity Reconciliation Act (1996).

Second, we examine factors affecting both illegal immigration and attempts to stop it. Economic conditions in Mexico are a key determinant of illegal immigration in the United States. Yet, U.S. border enforcement fails to rise in response to what appear to be predictable surges in attempted illegal entry. In addition, the U.S. Immigration and Naturalization Service (INS) fails to monitor aggressively those who employ illegal immigrants. These enforcement practices highlight the conflicting mandate of the INS. The INS is legally obliged to enforce against illegal entry, but severe enforcement brings opposition from industries that rely heavily on immigrant labor. Reinstating the temporary immigration of seasonal labor would convert illegal migrants into temporary, legal ones, but, as we explain, will not necessarily give the U.S. government greater control over the inflow of labor from abroad.

Third, we examine the fiscal impact of immigration. Though exact estimation is difficult, it appears that the long-run net fiscal impact of immigration on the aggregate U.S. economy is very small. This overall neutrality hides two important features of immigration and U.S. public finances. One is that the net benefits of immigration may be negative in the short-run as many immigrant are relatively poor and use relatively more public services, such as education. A second is that the fiscal costs of immigration are concentrated in the “gateway” states that are home to most immigrants, while most fiscal benefits from immigration go to the federal government. The U.S. reform of welfare policies in 1996 has increased this mismatch by devolving the administration of public assistance to state and local governments. The net fiscal contribution of future immigrants will depend crucially on the age and schooling of new arrivals.

Fourth, we consider the factors that influence U.S. immigration policymaking. We identify the preferences of the main actors in the U.S. immigration debate and how successful these actors are in influencing national policymakers. From the opinions of individual citizens about policy to votes on legislation by members of Congress, it is clear that immigration policymaking is affected by the perceived economic consequences of policy alternatives and, in particular, on the distribution of these economic effects. Less-skilled workers are more likely to support restrictionist policies while the employers of these workers generally favor liberalization. The influence of both these groups is observable in the voting behavior of members of Congress. Beliefs about the impact of immigration on the welfare state also affect policymaking. There is

⁶ We focus on a specific set of policy issues and do not attempt a broad coverage of U.S. immigration issues. For recent, more expansive treatments of immigration in the United States, see Smith and Edmonston (1997) and Borjas (1999). For an overview of U.S. immigration from Mexico, in particular, see Mexico-United States Binational Migration Study (1998).

consistent opposition to family-based immigration from political conservatives who favor a smaller welfare state both in the electorate and in Congress.

In the next section, we set the stage for the discussion by giving an overview of trends in U.S. immigration and immigration policy. The overview is followed by the four main sections of the paper. We conclude by considering the potential impact of proposed changes in U.S. immigration policy on the U.S. economy.

2. Immigration and Immigration Policy in the United States

Any policy that restricts immigration must establish a criterion for the admission of foreign nationals. U.S. policy gives explicit preference to family members of U.S. citizens, with some consideration for an individual's occupational background. Whether desired or not, this policy appears to have contributed to rising immigration of individuals with relatively low levels of discernible skill. Given ample opportunities for illegal immigration, the U.S. government does not exercise full control over which individuals gain entry to the country. By choosing to concentrate enforcement efforts at the border, rather than at the place of employment, the U.S. implicitly gives preference to illegal immigrants who are able and willing to evade border authorities. This may have further contributed to immigration of the less skilled.⁷ In this section, we briefly review U.S. immigration policy and then discuss recent developments in immigration patterns and the economic performance of immigrants.

2.1 An Overview of U.S. Immigration Policy

U.S. immigration policy is based on a quota system, the main elements of which were established by the Hart-Celler Immigration Bill of 1965, an amendment to the Immigration and Nationality Act of 1952 (Smith and Edmonston, 1997).⁸ Under the current system, the Immigration and Naturalization Service (INS) assigns applicants for admission to one of seven categories, with each having its own quota level.⁹ The law guarantees admission to immediate family members of U.S. citizens. Specific quotas are assigned to other family members of U.S. citizens, immediate family members of legal U.S. residents, individuals in special skill categories, and refugees and asylees facing persecution in their home countries. Of the 660,447 individuals the INS admitted in 1998, 72.0% gained entry as family members of U.S. citizens or legal residents, 11.7% gained entry as skilled workers, 8.3% were refugees or asylees, and 8.0%

⁷ Crossing the U.S.-Mexico border illegally imposes costs of time, physical duress, and money, and precludes finding legal employment in the United States. All else equal, illegal immigration under these circumstances is likely to be more attractive to individuals expecting to be employed as manual laborers.

⁸ The first broad numerical limits on immigration (besides bans on Chinese immigration imposed in the 19th century) were embodied in the Immigration Act of 1924, which sharply restricted immigration overall and from outside Western and Northern Europe in particular. The 1965 amendments were to the Immigration and Nationality Act of 1952, which had created skill-based categories for immigration (though without changing restrictions on national origin).

⁹ The most recent change to immigration levels was the Immigration Act of 1990, which set a flexible cap for overall legal admissions at 675,000 of which 480,000 would be family-based, 140,000 would be employment-based, and 55,000 would be "diversity immigrants." The law also set temporary immigration at 65,000 for the H-1B program (later increased temporarily; see note X) and 66,000 under the H-2B program (see note X), and created new categories for temporary admission of workers (O, P, Q, R). Subsequent legislation created categories for temporary immigration of professional workers from Canada and Mexico as part of the North American Free Trade Agreement (INS, 2000).

were in other categories.¹⁰ Additional admissions to the United States occur through temporary work visas, the two most common classes of which are for highly-skilled workers and short-term manual laborers.¹¹

Though the United States does not set the level of illegal immigration explicitly, existing policy in effect allows substantial numbers of illegal aliens to enter the country. Warren (1999) estimates that in 1997 there were 5.3 million illegal immigrants in the United States, which was 20.1% of the foreign-born U.S. population in that year, up from 2.3 million in 1987.¹² Most such individuals gain entry either by crossing the U.S.-Mexico border illegally or by overstaying temporary visas. The INS, and in particular the U.S. Border Patrol which the INS oversees, enforces against illegal immigration mainly by policing the U.S.-Mexico border and other points of entry and by seeking to prevent the smuggling or employment of illegal aliens.

Current U.S. policy on illegal immigration is based largely on the Immigration Reform and Control Act (IRCA) of 1986, which made it illegal to employ illegal aliens, mandated monitoring of employers, and expanded border enforcement.¹³ IRCA also offered amnesty to illegal aliens who could establish that they had resided in the United States continuously since 1982. As a result of IRCA, the INS granted legal residence to 2.7 million individuals, 2 million of whom were Mexican nationals (see Figure 2.1).¹⁴ In 1998, the Border Patrol apprehended 1.5 million illegal aliens at the U.S.-Mexico border and 124,000 illegal aliens through other enforcement efforts (INS, 2000). While the U.S. Border Patrol has enforced the border against illegal immigration since 1924, the modern experience of high levels of illegal immigration dates back only to the 1960's and the end of the *Bracero* Program (1942-1964), which allowed

¹⁰ The Refugee Act of 1980 created systematic procedures for the admission of refugees “of humanitarian concern,” eliminating refugees and asylees as a category of the existing quota-preference system (INS, 2000).

¹¹ To obtain a temporary work visa, a worker must be sponsored by a U.S. employer. The H-1B visa applies mainly to workers in high-tech industries. It was created in 1990 to permit foreigners with a college degree to work in the United States for a renewable three-year term for employers who petition on their behalf. In 1998, the U.S. Congress raised the annual number of H-1B visas from 65,000 to 115,000 for a period of three years. The H-2B visa, created by the Immigration Reform and Control Act of 1986, applies to seasonal laborers, most of whom work in agriculture. The bureaucratic steps needed to obtain H-2B visas are onerous, which appears to limit their use.

¹² Estimates for 2000 put the number of illegal immigrants at 6.5 million (Camarota, 2001).

¹³ Prior to this time it had been illegal to “harbor” illegal aliens but not to employ them (Calavita, 1992).

¹⁴ Subsequent to IRCA, several pieces of legislation modified U.S. treatment of illegal aliens. The Personal Responsibility and Work Opportunity Reconciliation Act of 1996 barred illegal aliens from most federal, state, and local government benefits and required the INS to verify an individual's immigration status before he or she could receive most types of federal public benefits. The Illegal Immigration Reform and Personal Responsibility Act of 1996 mandated increases in border enforcement and surveillance; increased penalties for smuggling, illegal entry, and failure to depart; instituted 3- and 10-year bars for legal admissibility in the United States for individuals found to have entered the country unlawfully; and further restricted access of illegal aliens to federal public benefits (INS, 2000).

seasonal farm laborers from Mexico and the Caribbean to work in U.S. agriculture on a temporary basis.

2.2 Recent Trends in U.S. Immigration

The current U.S. immigration wave is the second the country has experienced in the last century and a half. Both are clearly evident in Figure 2.1, which shows admissions of new legal immigrants by year from 1820 forward. The first wave lasted from the 1880's to the 1920's, bringing in a total of 26 million immigrants. The current one began in the 1960's and has accelerated in each subsequent decade. There are a number of salient features about current immigration in the United States.

Immigrants are concentrated at the extremes of the skill distribution. Table 2.1 shows the educational profile of immigrant and native men and women over the period 1960-1998. Immigrants are much more likely to have low levels of schooling than are U.S. native-born individuals. In 1998, 34% of immigrant men had not completed the equivalent of a high-school education, compared to only 9% of U.S. native men. At the same time, immigrants are also more likely to have very high levels of schooling than are U.S. natives. In 1998, 13% of immigrant men had at least a master's degree, compared to 10% of U.S. native men. In the 1960's, immigrant men had educational profiles that were more similar to U.S. native men, indicating that the average relative educational attainment of immigrant men has been declining over the last several decades. This reflects in part a shift in the national composition of new immigrants, as shown in Table 2.2, from countries in Europe, where education levels are similar to the United States, to countries in Asia and Latin America, where average education levels are lower than the United States. Women show the opposite pattern from men, as the educational profiles of immigrant and native women have become more similar over time.

Immigrants earn less than U.S. natives. Table 2.1 shows that in 1998 the average hourly wage for immigrant men was 23% less than that for native men and the average hourly wage for immigrant women was 12% less than that for native women. Such immigrant-native wage disparities have not always existed. In 1960 and 1970, immigrants earned as much or more than native workers. These changing wage patterns reflect the increasing concentration of immigrants at relatively low education levels. We see this more clearly by examining the wages of recent immigrants. In 1960, the average hourly wage of recent immigrant men was 13% less than that

for native men; by 1990, this so-called entry wage gap had reached 34%. The rise in the entry wage gap falls somewhat (17% in 1960 versus 29% in 1990) when we control for differences in age and education between immigrants and natives (Borjas, 1999).

Immigrants tend to concentrate in specific U.S. regions. Table 2.3 shows the immigrant share of the population for the nation as a whole and for selected U.S. states. Upon arriving in the United States, immigrants tend to settle in the "gateway" states of California, Florida, Illinois, New Jersey, New York, and Texas. In 2000, these states were home to 73% of immigrants but only 36% of natives. Within these states, most immigrants live in a few large cities. In 2000, 53% of immigrants, but only 23% of natives, lived in just six consolidated metropolitan areas, Los Angeles, New York, San Francisco, Miami, Chicago, and Washington-Baltimore (Camarota, 2001). California stands out as the state of choice for recent immigrants. The share of the state's population that is foreign born rose from 10% in 1970 to 26% in 2000 (compared to the rise in the nation as a whole from 5% to 10%). California has attracted a disproportionately large share of less-educated immigrants. In 1998, the state was home to 32% of all immigrants and 40% of immigrants who had not completed high school, compared to 10% and 9%, respectively, in 1970 (Borjas, 1999). The state is also home to a disproportionate share of illegal immigrants, as shown in Table 2.4. In 1996, an estimated 40% of illegal immigrants in the United States resided in California and another 41% of illegal immigrants resided in one of the other five gateway states.

Immigrants tend to concentrate in specific occupations and industries. Table 2.5 shows the distribution of native and foreign-born workers by occupation for 2000. The table divides the foreign-born into naturalized U.S. citizens, who are more likely to have been in the country for a long period of time, and non-citizens, who are more likely to be recent arrivals and to be undocumented. The occupational profiles of naturalized foreign-born residents are similar to those of native-born residents. Non-naturalized immigrants, however, are much less likely to be managers, professionals, or administrative staff and much more likely to be manual laborers or to work in services, construction, or agriculture. This latter set of jobs are what we would expect for workers who had relatively low levels of education and relatively little U.S. labor-market experience. Table 2.6 shows the share of workers who are foreign born by education level and U.S. industry. In 1990, while immigrants accounted for 18.7% of all workers with less than a high-school education, they accounted for more than 30% of workers in agriculture, apparel, food products, and household services. Immigrants with a college education were disproportionately

concentrated in apparel and lodging, personal, and household services. In these industries, highly-educated immigrants may be more likely to function as entrepreneurs than as day laborers (perhaps hiring workers of the same nationality).

3. How Do Economies Adjust To Immigration Inflows?

One important consideration for U.S. immigration policy is the economic impact of arriving immigrants. How does an economy like the United States absorb immigrant inflows? The commonly assumed answer is via wage pressures. This perception has helped make the labor-market impact of immigration a politically charged issue.

"There are advantages [to immigration]. Businesses can hire new immigrants at lower pay; and consumers gain because reduced labor costs produce cheaper goods and services. But, generally speaking, the gains from high immigration go to those who use the services provided by new immigrants. If you are likely to employ a gardener or housekeeper, you may be financially better off. If you work as a gardener or housekeeper, or at a factory job in which unskilled immigrants are rapidly joining the labor force, you lose. The last twenty years of immigration have thus brought about a redistribution of wealth in America, from less-skilled workers and toward employers."

Pat Buchanan, "To Reunite a Nation," speech delivered in Yorba Linda, CA, January, 18, 2000.

But wages are only one possible adjustment mechanism in economies like the United States that are open to flows of goods, capital, and ideas. In this section, we delineate these adjustment mechanisms by sketching out some standard models used in both labor and international economics. Immigration-induced changes in labor supplies can be absorbed via changes in relative factor prices, but they also can be absorbed in at least three other ways: changes in industrial specialization, migration of labor and/or capital, and changes in underlying production technology.

Our discussion then turns to the empirical evidence. Most research on immigrant absorption has looked for wage impacts, at the regional and/or national level. There is a large literature on regional wage responses to regional immigrant inflows, and the repeated finding is that immigration has a small negative impact, at best, on local native wages (for surveys see Borjas, 1994 and 1999; Borjas, et al, 1997). National wage effects do not seem to be particularly large, either. There is a relatively small literature on whether native migration responds to immigrant inflows, with mixed results. We will discuss evidence that output-mix and/or technology changes have helped accommodate immigrant inflows and thus account for the lack of obvious wage pressures.

After evaluating the past, we look to the future. Although the recent U.S. experience seems to show that wage adjustments have not predominated, the conditions that have contributed to this outcome may not persist. We identify possible changes in the economic environment, both at home and abroad, under which the wage impacts of immigration could become more pronounced. If this happens, the political economy of immigration may shift: the larger is the impact of immigration on wages, the stronger demands for changes in the level or composition of immigration are likely to be.

3.1 How Does the U.S. Economy Absorb Immigrants: Theoretical Framework

To elucidate how economies can absorb immigrant inflows, this section briefly summarizes three models of the labor market: the area-analysis model, the factor-proportions-analysis model, and the Heckscher-Ohlin trade model. The first two models are commonly used in labor economics (we borrow the terms from Borjas, et al, 1996), while the third is the standard model in international trade.

Consistent with the facts about recent U.S. immigration presented in section 2, in all models we treat the U.S. immigrant inflow as an increase the relative supply of less-skilled workers. To maintain a simple focus on different skill groups in the labor force, in all models we assume just two factors of production, skilled labor and unskilled labor. To maintain focus on equilibrium wage determination, in all models we assume that wages are sufficiently flexible to ensure full employment. Of course, how realistic this assumption is varies in the real world. Our country of interest, the United States, is commonly thought over the medium-to-long run to have flexible labor markets that are reasonably approximated by the full-employment/flexible-wages assumption. In contrast, in recent years many European countries have displayed much higher unemployment rates and more wage rigidity. For these cases, it may be more realistic to consider unemployment as another possible adjustment mechanism.¹⁵

The Area-Analysis Model

This model assumes both a single aggregate output sector, the factor demands for which can be proxied by the factor demands for a single representative firm. This model also assumes

¹⁵ We note that the U.S.-Europe contrast was reversed before the early 1970s: in earlier decades U.S. unemployment rates were generally higher than those in Europe. Davis (1998) models how the labor-market impacts of trade depend on whether or not wages clear at full employment.

distinct, geographically segmented labor markets within a country. This assumption is likely untrue in the very long run, but it may be true over shorter time horizons thanks to frictions such as information and transportation costs that people (both natives and immigrants upon arrival) must incur to move. Empirically, U.S. "local" labor markets are usually defined by states or metropolitan areas. Each local market has its own equilibrium wages determined by local supply and demand.

If there is literally no mobility among local labor markets, the effects of immigration on wages are limited entirely to the "gateway" communities where immigrants arrive. In each community, arriving immigrants must price themselves into employment by accepting lower wages and thereby inducing profit-maximizing firms to demand them. If within each skill category natives are perfect substitutes for immigrants, then wages move for natives as well as immigrants. Thus, immigrant inflows raise the local skill premium, with larger immigrant inflows meaning larger wage changes. At unchanged product prices, real wages move commensurate with relative wages: skilled real wages rise, while unskilled real wages fall.

Figure 3.1 displays the labor market for the area-analysis world. The horizontal axis plots the local supply of skilled labor relative to unskilled labor, while the vertical axis plots the local skill premium. The local relative-labor-demand schedule RD slopes downward everywhere, consistent with most technologies one might assume for the single representative profit-maximizing firm. Initial relative labor supply is given by the schedule RS_0 , with initial equilibrium at point E_0 and relative wages $(w_S/w_U)_0$. Immigration shifts the supply schedule back to RS' , raising the local skill premium to $(w_S/w_U)'$. Again, for fixed product prices real wages change, too.¹⁶

The Factor-Proportions-Analysis Model

Like the previous model, the factor-proportions-analysis model also assumes a single output sector employing all workers. The fundamental difference between the two is this model assumes a national labor market. Thanks to sufficient mobility of natives (and immigrants upon arrival) there are no geographically segmented "local" labor markets. Natives can leave gateway

¹⁶ Consistent with our full-employment assumption, the relative-supply schedule is vertical: all workers are sufficiently willing to work that they price themselves into employment at any going relative wage.

communities when immigrants arrive; immigrants can move on to other communities; or natives can choose not to enter gateway communities as planned pre-immigration.

The assumption of a national labor market means that the wage pressures created by immigration spread beyond gateway communities. Arriving immigrants must still price themselves into employment as described above, but now wages adjust throughout the entire national labor market.

Graphically, the factor-proportions-analysis model also looks like Figure 3.1—but with the key difference that now this figure represents national, not local, conditions. Here, immigration shifts relative labor supplies and thus wages economy-wide.

The Heckscher-Ohlin Model

The key assumption of the HO trade model is that there are more tradable products (i.e., sectors) than primary factors of production, with products differentiated by their factor intensities. Multiple products are essential for establishing many fundamental trade-theory results, such as comparative advantage.¹⁷ The HO framework usually assumes a single national market for each factor, although many of its key ideas apply to regions within countries as well. We maintain this assumption for now, but revisit it in our empirical discussion of the next subsection.

With these assumptions, in equilibrium a country chooses (via the decentralized optimization of firms) the "output mix" that maximizes national income subject to the constraints of world product prices, national factor supplies, and national technology. This output mix consists of both which products actually get produced and the quantities of production. In turn, this output mix helps determine the country's national factor prices. The general intuition is that the technology parameters and world price for each produced sector help determine national wages. In the standard case where the country makes at least as many products as the number of primary factors, equilibrium wages are a function of just the world prices and technology parameters of the produced sectors. These wages do not depend on the prices and technology of the non-produced sectors. They also do not depend directly on the level of endowments, only indirectly through the endowments' role in selecting the product mix.

¹⁷ Without at least two products, countries (in a static setting) would have no incentive to trade and thereby more-optimally allocate scarce national resources. Ethier (1984) generalizes the HO model to settings with many products.

The effects of immigration on wages depend on the initial product mix, on the size of the immigration shock, and on whether the country is large or small (i.e., on whether its product mix does or does not have any influence on world product prices). Consider the standard case where the initial output mix is sufficiently diversified that wages depend on just world prices and technology.

In this case, with "sufficiently small" shocks the country absorbs immigrants by changing its output mix as predicted by the Rybczynski Theorem (1955): the same products are produced, but output tends to increase (decrease) in the unskill-intensive (skill-intensive) sectors. Whether wages change depends on whether the country is big or small. If the country is small, world prices do not change and thus there are no wage effects. This insensitivity of national wages to changes in national factor supplies Leamer and Levinsohn (1995) call the Factor-Price-Insensitivity (FPI) Theorem. If the country is large, wages do change in the spirit of the Stolper-Samuelson (1941) Theorem: the relative price of unskill-intensive products declines, which tends to lower (raise) wages for unskilled (skilled) workers.

With "sufficiently large" immigration shocks, national wages do change. Large enough shocks induce the country to make a different set of products, which entails a different set of world prices and technology parameters and thus different wages. This absorption of large shocks via changes in both output mix and wages holds whether the country is big or small: in either case wage inequality rises.

Figure 3.2 displays the national labor market for the case of a small HO country with three products. The distinguishing feature is the shape of relative labor demand. It has two perfectly elastic portions, each of which corresponds to a range of endowments for which FPI holds. The national output mix varies along the demand schedule. A different set of two products is made on each elastic part; accordingly, different relative wages prevail on each elastic part. On the downward-sloping portions the country makes only one product. Along these portions output-mix changes are not possible, so immigrants must price themselves into employment by changing wages. Point E_0 designates the initial labor-market equilibrium, with relative labor supply RS_0 and relative wages $(w_s/w_u)_0$. Two immigration shocks are shown. The "sufficiently small" immigration shock shifts RS_0 to RS' . Relative wages do not change, as immigrants trigger Rybczynski output-mix effects with no product-price changes. The "sufficiently large" shock shifts RS_0 to RS'' . The country now produces a new set of products.

As a result the unskilled wage falls relative to the skilled wage (to (w_S/w_U) "), and with fixed product prices this relative-wage decline will be a real-wage decline as well.¹⁸

Other Adjustment Mechanisms For Immigrant Inflows

Our discussion thus far has described two possible mechanisms by which economies absorb immigrants. The first is wage changes, a mechanism potentially present in all three frameworks discussed. The second is output-mix changes, as predicted by the HO model.

A third possible mechanism is native labor-supply changes. One version of this mechanism contrasts the area-analysis and factor-proportions frameworks: even if immigrants arrive into gateway communities, they may trigger native labor-supply flows that dissipate any wage effects throughout the entire country. More generally, during the period of immigration inflows there may be changes in native labor supply unrelated to immigrant inflows. For example, it is well known that as the United States has been receiving larger immigrant inflows in recent decades, the educational mix of natives has been rising. But to the extent that natives and immigrants are sufficiently substitutable within each skill category, what may matter for equilibrium wages is not the immigration-related shifts in RS but rather the overall shifts in RS. If immigrant and native labor-supply changes move against each other, then the net supply change depends on the relative magnitudes.

A fourth possible adjustment mechanism is contemporaneous shifts in relative-labor demand. Our HO discussion specified an endogenous shift in labor demand, via output-mix effects. But during periods of immigrant inflows there may be other labor-demand shifters unrelated to immigrant inflows. One is trade-related shifts via the Stolper-Samuelson process. A large number of recent papers have looked for Stolper-Samuelson wage pressures operating on the United States in recent decades (see Slaughter, 2000 for a survey).

¹⁸ Three additional comments are in order on Figure 3.2. First, it is important to emphasize that an economy would need to satisfy several crucial HO assumptions for it to manifest portions of RD that were truly perfectly elastic. Relax these assumptions and the perfectly elastic portions would start to "tilt." For example, as discussed in the text, if the country could affect world prices, then output-mix changes would trigger Stolper-Samuelson wage adjustments via world-price changes. Or if some factors were attached ("specific") to certain sectors, this would inhibit output adjustments. Second, underlying the downward-sloping portions of RD is the assumption of flexible production technologies with factor substitutability. With Leontief technology these portions would be vertical. Third, along the national demand schedule the country's output mix progresses according to sector factor intensities. The likely output mixes are as follows. Along the leftmost branch of RD the country makes only the most unskill-intensive product. Along the first flat it makes this product and the "middle" intensity product, switching to only the middle product along the middle downward-sloping branch. The country picks up the most skill-intensive product as well along the second flat; finally, along the rightmost branch it makes only the skill-intensive product.

Another possible labor-demand shifter is technological change. There is a large literature that documents how U.S. technological change in recent decades appears to have shifted firms' relative demand away from less-skilled workers and towards more-skilled workers (Bound and Johnson, 1992; Katz and Murphy, 1992; Berman, Bound, and Griliches, 1994; Autor, Katz, and Krueger, 1998; Katz and Autor, 1999). This skill-biased technological change (SBTC) may tend to offset labor-supply shifts from immigrants and/or natives.¹⁹ Economic openness may matter a great deal for SBTC within the United States: regional openness to the flow of ideas may mean innovations discovered in particular locations (e.g., Silicon Valley) diffuse throughout the entire country.

Summary

If one assumes economies are closed to flows of factors, goods, and ideas, then immigrant inflows must be absorbed via wage changes. But to the extent that U.S. regions and/or the country overall is open to these flows, other adjustment mechanisms are possible: native factor flows, output-mix changes and resultant trade flows, technological change. As we have discussed, these other adjustment mechanisms may be endogenous responses to immigrant inflows or may be largely unrelated. Either way, if these other mechanisms operate then immigrants need not pressure wages as is commonly assumed. Having set out these possibilities, we now turn to the empirical evidence.

20

3.2 How Does the U.S. Economy Absorb Immigrants: Empirical Evidence

Wages and Labor-Supply Adjustments

Wage changes are the obvious first place to look for immigrant absorption. There is by now a very large literature on this issue (for comprehensive surveys see Borjas, 1994 and 1999 and Friedberg and Hunt, 1995). Most studies have adopted the area-analysis framework, in light of the evidence that recent immigrants concentrate in gateway regions (see Table 2.3). The

¹⁹ See Gandal, Hanson, and Slaughter (2000) for a discussion of how skill-biased technical change appears to have helped Israel absorb very large inflows of highly-skilled Russian immigrants.

²⁰ Even adjustment mechanisms commonly presumed to be unrelated to immigrant inflows may not be. For example, Acemoglu (1999) models how the technologies firms adopt endogenously respond to shifts in labor supplies. Empirically, Saxenian (1999) studies how immigrants have contributed to growth in Silicon Valley in recent years: She reports that in 1990 immigrants accounted for 32% of the region's scientific and engineering workforce, and that in 1998 Chinese and Indian engineers were running 25% of the region's high-technology businesses. Rauch and Trindade (2001) estimate that Chinese immigrants stimulate more bilateral trade between their host countries and China. Gaston and Nelson (2001) also discuss how immigrants can be absorbed into host-country labor markets.

general approach of these studies is to correlate the fraction of immigrants in a region with native wages (and sometimes other outcomes, like un/employment rates). Different studies take different approaches to measuring regions (cities, MSAs, states); distinguishing skill groups (just distinguish natives from immigrants—which in turn may be separated between new and older arrivals—or separate further, especially by skills measured via educational attainment or occupation); econometric specification (levels, time differences of varying lengths); and treatment of potential endogeneity between immigrant inflows and local labor-market conditions (use OLS, or instrument for immigrant inflows using stocks/flows of immigrants from earlier periods). A representative group of studies includes Borjas (1987), Altonji and Card (1991), LaLonde and Topel (1991), and Card (2001).

The near uniform finding is that immigration has, at most, a small negative effect on wages. Typical estimates are that a 10% increase in the fraction of immigrants in a region lowers native wages by less than 1% (often an amount not statistically different from zero). This finding has been obtained from a wide range of studies under a wide range of treatments of the relevant measurement, specification, and estimation issues outlined above. It has even been found in event studies such as Card (1990), who documented that although the 1980 Mariel boat lift into the Miami-area labor market unexpectedly increased the local labor supply by 7% in a four-month period, this shock had no discernible effect on native wages or unemployment in the area.

There is ample evidence, then, that regional variation in immigrant inflows generate small pressures, at best, on regional wages. One possible reason for this, suggested by the factor-proportions framework, is that native migration patterns respond to immigrant inflows such that total labor-supply shifts across regions are more uniform than that suggested by natives alone.

It is commonly thought that inter-regional labor mobility is high in the United States relative to most other advanced economies. In Europe, by contrast, inter-regional labor mobility appears to be much lower (Abraham, 1996). It is clear that U.S. labor tends to migrate from low-wage to high-wage regions, at least over medium to long time horizons (Topel, 1986; Blanchard and Katz, 1992). Of particular relevance for immigration, low-skill workers appear to be less mobile across regions than high-skill workers (Borjas, Bronars, and Trejo, 1992; Bound and Holzer, 1996).

But what about labor mobility related specifically to native responses to immigration inflows? There is some evidence that natives respond to immigration inflows by exiting and/or choosing other destinations. Borjas, et al (1997) document that before 1970, California's population

growth was driven both by immigrants and natives. But since 1970, after the start of large-scale immigration into California and the overall country (see section 2), California population growth was almost entirely accounted for by immigrants alone. Borjas, et al (1997, p. 21) note that, “This suggests that the increasing number of immigrants who chose California as their destination ‘displaced’ the native net migration that would have occurred and thus diffused the economic effects of the immigration from California to the rest of the country.”

Does the California example of native responses to immigrant inflows generalize to the rest of the country? Different researchers have reached sharply different answers. A representative study answering “no” is Card (2001). Using a panel of skill-group/city observations, he regresses the city’s net outflow rate of natives or earlier immigrants in a skill group on that city’s contemporaneous inflow rate of new immigrants in that skill group. A wide range of other control regressors are used, and immigrant inflow rates are also instrumented using earlier immigrant stocks (a sensible instrument given the ongoing tendency of immigrants to concentrate in gateway locations). This analysis finds that mobility flows of natives and earlier immigrants are not very sensitive to new-immigrant inflows—indeed, if anything they are slightly complementary to new-immigrant flows.

The opposite conclusion is reached by Borjas, et al (1997). For an initial specification that parallels Card’s, they, too, find that native-population growth rates for states (either states’ entire population or population by skill groups) are positively correlated with contemporaneous immigrant-population growth rates. But they argue that these specifications, which correlate across states contemporaneous growth rates of natives and immigrants, implicitly assume that all states would have had the same growth rate of natives absent the immigrants. If this assumption is not warranted—i.e., if each state had its own pre-immigration growth path—then contemporaneous correlations without some kind of pre-immigration control are misleading.

Borjas, et al estimate a difference-in-differences specification that compares each state’s native and immigrant growth rates “post-immigration” (i.e., 1970 to 1990) with its growth rates “pre-immigration” (i.e., 1950 or 1960 to 1970). Using the earlier growth rates as their counterfactual control, they now estimate a negative correlation (sometimes significant, sometimes not) between native population growth and immigrant inflows. With this different counterfactual in their analysis, these authors conclude that native population flows do respond to immigrant inflows.

As in the factor-proportions framework laid out in the previous sub-section, with this kind of regional labor mobility immigration inflows should trigger national, not regional, wage adjustments. Accordingly, Borjas et al calculate these national wage impacts as suggested by Figure 3.1. First, they calculate the labor-supply shifts induced by immigrants across various skill groups. Immigrants post-1970 contributed most to the national supply of high-school dropouts, with smaller contributions for higher skill groups. Second, they translate these labor-supply shifts into wage changes using various assumed values for the elasticity of national labor demand. They conclude that immigrants can account for around half of the post-1980 decline in relative earnings of high-school dropouts, but can account for less than 10% of the rising college/high-school wage premium. Thus, the national wage effects of immigrant are calculated to be sizable only for the very least-skilled workers.

The question of how much native population flows respond to immigrant inflows raises the related question of how large these two sets of flows are. One possible reason immigrant inflows might not substantially pressure wages is that these inflows are small relative to native labor-supply changes. If natives and immigrants are sufficiently substitutable within various skill groups, then small immigrant wage effects might simply result from small immigrant labor-supply changes relative to native changes. This possibility that natives tend to dominate immigrants in overall supply changes is suggested by the just-described wage findings of Borjas, et al.

Table 3.1 shows the share of U.S. state labor forces accounted for by native and foreign-born workers in four education categories (high-school dropouts, high-school graduates, those with some college, college graduates) in changes over the period 1980 to 1990. Data are reported for the overall country, the six immigration-gateway states (see Table 2.3), and six other large states. Looking just at immigrants shows that these workers generally increased their share of the labor force in all education categories. This is most true for high-school dropouts in the gateway states (especially California), broadly consistent with the rising immigrant presence documented in section 2.

But the main message of Table 3.1 comes from comparing the relative magnitudes of native versus immigrant changes. In the country overall and in every state shown, except California, the impact of immigrants on the composition of the labor force is overwhelmed by changes in the educational attainment/labor-force participation of natives. Everywhere there is a

large decline in the labor-force shares of less-educated native workers and a large increase in the labor-force shares of more-educated native workers. This relative-supply shift is due to a combination of retirements and other "exits" from the labor force, rising educational attainment of new labor-force entrants, and further education of continuing labor-force participants. These movements in native educational attainment swamp the comparatively small changes in immigrant labor-force shares. The one exception is California, where less-educated immigrant labor-force entrants to the labor force nearly offset exits of less-educated native workers.

Table 3.2 combines the native and immigrant share changes in Table 3.1 to show the net labor-supply shifts in the overall country and in specific states. The clear message is skill upgrading of the labor force, both for the country overall and for individual states. Again, California is an outlier: relative to the rest of the country, it did not lose the less-than-high-school segment of its labor force—thanks, as Table 3.1 showed, to arriving immigrants offsetting native exits.

Although not shown in Table 3.2, this pattern of skill upgrading of the U.S. labor force has been going on for decades—and it continued over the 1990s as well. Table 3.3 shows this longer-term perspective appears in Table 3.3, which reports for selected years the distribution of the U.S. adult population across four education categories. The skill upgrading for the 1980s shown in Table 3.2 is part of trend dating back at least 60 years. As we will discuss in section 3.3, however, this process of strong native skill upgrading is *not* forecast to continue in the coming generation (Smith and Edmonston, 1997). But at least for recent decades, the clear message is that net changes in both national and regional U.S. relative labor supplies have been driven by natives, not immigrants. This may make the apparent absence of wage impacts of immigration seem less puzzling.

Technology and Output-Mix Adjustments

So how are these net changes in labor supply absorbed? Beyond wages and factor flows, two other adjustment mechanisms highlighted in the previous sub-section were output-mix effects and other labor-demand shifters such as technological change.

Take technology first. Table 3.2 shows an increase in the U.S. supply of more-skilled relative to less-skilled workers—during a period in which the U.S. returns to skill, as discussed earlier, were rising. From the closed-economy area-analysis or factor-proportions perspectives in Figure 3.1, in the face of rising relative supplies of skill, the skill premium can be rising only if

relative labor demand shifts out even more. SBTC is a prime candidate for such a shift.²¹ From the HO trade perspective, the supply shifts in Table 3.2 will have either no wage impact (with FPI) or will lower the skill premium. Thus, for the rising skill premium along with these supply shifts to be caused by technological change, this technological change would have to shift “up” the RD schedule in Figure 3.2. This upward shift in RD would require technology innovations to be concentrated in the skill-intensive sectors.²²

What empirical evidence is there on the role of technological change? At the national level, as outlined in the previous sub-section there appears to have been pervasive SBTC within U.S. industries in recent decades. Although the U.S. skill premium has been rising, firms within most U.S. industries have been hiring relatively more, not fewer, more-skilled workers. This employment shift towards skilled workers despite their rising cost strongly suggests SBTC. From the factor-proportions perspective, this raises the U.S. skill premium in the face of rising skill supplies so long as the demand shift predominates.²³ As for the sector bias of this pervasive SBTC, Haskel and Slaughter (2001) estimate that U.S. SBTC was in fact more extensive in skill-intensive sectors over the 1980s. Thus, from the perspective of either the factor-proportions or the trade frameworks, the data suggest SBTC has been an important adjustment mechanism over the 1980s.

The role of SBTC at the regional level is examined by Hanson and Slaughter (2001). For a sample of 14 U.S. states over the 1980s, they decompose changes in state employment by education category into changes in labor demand arising from output-mix changes across industries

²¹ More specifically, where the one-sector labor-demand curve is just the demand curve for a representative firm, for commonly assumed production technologies (e.g., CES) the only force that will shift relative labor demand is factor-biased technological change. Hicks-neutral technological change does not alter relative factor demands, and output-mix effects are not possible by construction.

²² Given the *shape* of RD in Figure 3.2, it is important to emphasize that its *position* depends on product prices and production technology. Changes in prices or technology shift the position of the relevant parts of RD, and wages change to restore zero profits in all sectors. At initial factor prices, any change in product prices or technology means zero profits no longer hold in one or more sectors. Producers respond by trying to expand output in now-profitable sectors and reduce output in now-unprofitable sectors. Relative labor demand increases for the factors employed relatively intensively in expanding sectors; labor demand decreases for the factors intensive in the contracting sectors. To restore equilibrium, at fixed labor supply, relative wages must respond to the demand shifts until all profit opportunities are arbitrated away. The key empirical implication of this intuition is that the wage effects of changes in product prices and/or technology tend to depend on their *sector* bias, i.e., on the distribution across sectors of induced profit changes. Any change that initially increases profits in a particular sector tends to raise the economy-wide wage for factor(s) employed relatively intensively in that sector. In terms of Figure 3.2, segments of RD tend to shift *up* when price growth and/or technological progress is concentrated in skill-intensive sectors. Conversely, segments of RD tend to shift *down* when these changes are concentrated in relatively unskilled-intensive sectors.

²³ As discussed in the text, the U.S. labor force has been skill upgrading for decades. But the skill premium has not been uniformly rising throughout this period; in particular, it declined during the 1970s. From the labor perspectives in Figure 3.1, a falling and then rising skill premium in the face of ongoing relative-labor-supply shifts requires SBTC to be initially slower and then faster. Thus, much of the empirical literature on SBTC and changing skill premia has examined whether the rising skill premium has been accompanied by an acceleration in SBTC (e.g., Autor, et al, 1998).

and changes in production techniques within industries. These changes in production techniques, in turn, they further decompose into national changes that mirror shifts in the rest of the country and state-specific changes. The national changes capture the contribution of national SBTC (and other national shocks); state-specific changes capture the contribution of state-specific changes in relative wages. Consistent with the area-analysis empirical results discussed earlier in this sub-section, they find that state-specific changes in production techniques contribute little to factor absorption. Had state-specific wage changes been important, we would have expected to see a much larger contribution from state-specific changes in production techniques, since these production techniques are a function of factor prices. Instead, states absorb changes in employment primarily through changes in production techniques that are common across all states. This is consistent with technology innovations flowing across U.S. states in a manner that happens to offset these states' rising supplies of more-skilled workers.

What about output-mix effects? We know of no study examining these effects at the national level. For U.S. states, Hanson and Slaughter (2001) use a set of accounting decompositions to examine the labor-demand mechanisms through which states absorb changes in labor supplies. One possible mechanism is changes in the mix of outputs of traded goods. To isolate this mechanism, they adjust observed changes in labor supplies both for labor-demand shifts related to national SBTC (because the Rybczynski theorem is a comparative-static notion with no other shocks) and for labor-demand shifts related to output changes among nontradables (because tradability matters for Rybczynski effects not to pressure wages). They find that these changes in "effective" labor supplies are accounted for largely by labor-demand changes mandated by output-mix changes among tradables.

To help make their output-mix findings concrete, they examine how the pattern of industrial specialization in California has evolved over time. Table 3.2 shows that relative to the rest of the country, over the 1980s California's labor force became more concentrated at both ends of the skill-distribution: it had far less of a fall in the high-school-dropout share of the labor force, and it had about the same growth in the college-graduate share.²⁴ From Table 3.1, we see that immigrants accounted for this relative growth in California nearly as much as natives did. Given these labor-supply shifts, the FPI logic of the HO framework would predict California to have

²⁴ Across the four labor groups in Table 3.2, the difference labor-share changes between California and the overall country were +5.6 (-1.3-(-6.9)) for high-school dropouts, -1.8 (-6.6-(-4.8)) for high-school graduates, -3.5 (3.6-7.1) for some college, and -0.4 (4.3-4.7) for college graduates.

shifted towards production in industries intensive in the use either of very low-skilled or very high-skilled labor.

This was precisely what happened. Table 3.4 reports California's six fastest-growing industries relative to the rest of the country over the 1980s (in terms of the California annualized growth rate of real value added less the U.S. annualized growth rate of real value added). Table 3.4 also reports the factor intensity of these six industries, with lower (higher) numbers indicating more skill-intensive (unskill-intensive) industries. Relative to the rest of the country, the six fastest-growing industries in California during this period were either very skill-intensive—machinery (much of which is computers), legal services, finance, insurance, and real estate—or were very unskill-intensive—textiles, apparel, and household services. Industry immigrant intensity is also reported in Table 3.4, with lower (higher) numbers indicating more (less) immigrant-intensive industries. The three unskill-intensive sectors were also among the most immigrant-intensive in California. This is consistent with the FPI logic of arriving less-skilled immigrants tending to gain employment in these unskill-intensive sectors.

To generalize beyond the high-growth industries in Table 3.4 to all sectors, we estimate the following simple regression equation for California:

$$(3.1) \quad (\text{relative output growth})_i = \alpha + \beta(\text{skill intensity})_i + \gamma(\text{skill intensity})_i^2 + \delta(\text{immigrant intensity})_i + \varepsilon_i \quad ,$$

where subscript i indicates industries and ε_i is an error term. Skill intensity is average employment of high-school dropouts relative to college graduates for 1980 and 1990; immigrant intensity is average employment of immigrants relative to all workers for the same years. Our expectation that California output growth relative to that in the rest of the country be highest in either unskill-intensive or very skill-intensive sectors, and in the immigrant-intensive sectors, suggests that (3.1) should reveal that $\beta < 0$, $\gamma > 0$, and $\delta > 0$. Table 3.5 reports estimation results from (3.1) using weighted least squares (with California industry output as weights; OLS results are qualitatively the same). The estimated coefficients are just as expected, with the two for skill intensity significantly different from zero at standard levels.

Figure 3.3 visualizes these estimation results. For each industry in California over the 1980's, Figure 3.3a plots actual output growth relative to the rest of the country against industry employment of high-school dropouts relative to college graduates; it also plots predicted output

growth calculated using the coefficient estimates for skill intensity and the constant from Table 3.5. Figure 3.3b is the analogous figure plotting actual and predicted output growth against immigrant intensity (average share of immigrants in total industry employment). The lines of best fit visualize clearly the regression results: output growth tended to be higher in either the very skill-intensive or the unskill-intensive sectors, and in immigrant-intensive sectors.

The case of the California apparel industry, one of the most immigrant-intensive in the state, is particularly compelling. Between 1970 and 2000, the state's share of national apparel employment rose from 6% to 24%. During the 1980's and 1990's it was one of the few states in which apparel employment actually grew. Relative to the rest of the country, California had average annual employment growth in apparel of 5% in the 1970's, 5% in the 1980's, and 7% in the 1990's.²⁵ About two-thirds of the state's apparel industry is located in Los Angeles, where many less-skilled immigrants live. In 1990, 75% of workers in California apparel were immigrants (up from 41% in 1970), compared with 13% of apparel workers in the rest of the nation (up from 10% in 1970) (McCarthy and Vernez, 1997).

Beyond these cross-industry output-mix effects, one final piece of evidence on the role of immigrants in California comes from looking at employment shifts within industries. Table 3.1 shows large declines in California's supply of natives in the two less-skilled groups, with incoming immigrants helping offset these declines. Independent of any cross-industry shifts, within California industries one would expect to see employers replacing the "disappearing" less-skilled natives with broadly comparable less-skilled immigrants.

Figure 3.4 shows widespread evidence of this within-industry substitution away from natives and towards immigrants. For each industry in California over the 1980s, Figure 3.4a plots the level change in the immigrant high-school dropout employment share against the level change in the native high-school dropout employment share; Figure 3.4b has native high-school graduates on the vertical axis. In all industries but one (leather goods) the native employment share was falling while the immigrant high-school dropout share was rising.²⁶ Thus, within all industries the mix of less-skilled workers was shifting away from natives and towards immigrants.

²⁵ In the rest of the country, apparel employment has declined since the 1970's.

Summary of Empirical Evidence on Adjustment Mechanisms

The large immigrant inflows into the United States in recent decades appear not to have triggered large wage adjustments, either at the regional or the national level. The largest estimates for wage pressures appear to be for native high-school dropouts at the national level; outside of this case, a wide range of studies finds no compelling evidence of wage pressures. This is partly because native labor-supply changes have been much larger than immigrant changes, and partly because these net labor-supply changes have been absorbed on the demand side via technology and output-mix changes.

3.3 How Does the U.S. Economy Absorb Immigrants: Future Prospects

Will the United States maintain its ability to absorb immigrants with very little wage pressures? To answer this question, start with the assumption that arriving immigrants will continue to be less skilled than natives, on average. Barring dramatic changes in U.S. immigration policy, this outcome seems likely (Borjas, 1999).

Supply-Side Adjustment Mechanisms

First, consider supply-side adjustment mechanisms. As discussed above, in recent decades shifts in U.S. labor supply from immigrants have been dominated by native labor-supply shifts. But Elwood (2001) forecasts that U.S. labor-force growth in the next 20 years will be very different from that of the previous 20. First, growth in the absolute size of the labor force will be much smaller: From 1980 to 2000 the overall labor force grew by 35% and the so-called prime age workforce—i.e., those aged 25-54—grew by a remarkable 54%. Elwood predicts that from 2000 to 2020 these growth rates will fall to only 16% and 3%, respectively. This is mainly because the currently prime-age baby boomers will move into retirement and will be replaced by a much-smaller generation.

Second, the dramatic skill-upgrading of the U.S. labor force will largely stop. From 1980 to 2000 the college-educated share of the labor force rose by over eight percentage points, from 21.6% to 30.2%. But from 2000 to 2020, Elwood's baseline prediction is that the college-educated share will rise less than two percentage points, to 31.7%. This is because the large, well-educated baby boomers will be replaced by a generation with only marginally higher

²⁶ The (unweighted) correlation of share changes in Figure 3.4a is -0.68 and in Figure 3.4b is -0.51 .

educational attainment (thanks to declining and then only slowly recovering college enrollment rates in the 1970s and 1980s).

Overall, it appears that the dramatic increase in size and skills of the U.S. labor force in recent decades will not be repeated. Much of this has to do with the aging of native baby boomers: as this large, educated group exits the labor force into retirement, their replacements will be fewer and not markedly more educated. Because these trends will be driven mainly by natives, immigration will potentially play a larger role in shaping net changes in U.S. labor supplies. With less skill upgrading of natives in coming decades, continued arrivals of less-skilled immigrants will be a more important force reducing the skill mix of the U.S. labor force. This suggests that arriving immigrants will pressure U.S. wages more in the future than they have in the past.

Demand-Side Adjustment Mechanisms

We think the possibility of output-mix effects is likely to grow, insofar as the assumptions underlying the HO framework are likely to grow more realistic. The tradability of many goods and services is rising, thanks to ongoing declines in natural and political trade barriers. Inter-industry labor mobility is also rising, thanks to sharp corporate restructuring, continued declines in private-sector unionization rates, and advances in information technology (e.g., job-matching Internet web sites like monster.com) that improve the technology matching workers with vacancies. One piece of country-level evidence is the declining U.S. share of world GDP. At the end of World War II, the United States accounted for about half of world output (and, arguably, an even greater share of output in the economically integrated world excluding largely autarchic countries like those behind the Iron Curtain). By 2000 this share was down to around one-fifth. At the level of individual industries there is at least anecdotal evidence of heightened product-market competition in recent years. For example, many have argued that new information technologies make markets thicker and more transparent.

Graphically, increased potential for output-mix effects means the shape of the U.S. labor-demand schedule will become more like that of Figure 3.2. What about the position of this demand schedule? One force working against U.S. less-skilled workers may be continued SBTC. Another may be the continued integration of China, India, and other low-income countries into the world economy. Entry into the world economy of these low-income countries is

communicated to the U.S. labor market via shifts in the RD curve. Entry of these countries increases the world relative supply of less-skilled labor; in turn, this tends to lower the world relative price of unskill-intensive products, such as textiles and toys. In Figure 3.2, these price changes shift up the portions of the U.S. RD curve along which the United States would optimally choose to produce these goods—i.e., portions corresponding to low skill mixes in the labor force.

Whether the United States will actually be producing these kinds of “exposed” unskill-intensive goods will depend on the position of the RS curve. As discussed at the outset of this sub-section, in coming decades immigration may very well exert a stronger downward pull on the skill mix of the U.S. labor force. Immigration and other labor-supply shifts may keep the national RS schedule “too far” to the left in Figure 3.2 such that U.S. less-skilled workers are exposed to shifts in RD due to China, India, etc. In contrast, countries with sufficiently skilled labor forces will be insulated from the “China effect” as they operate farther right on the RD schedule. For these countries, events in low-income countries do not affect relative wages; instead, low-income growth generates real-wage gains for all factors via lower prices for unskill-intensive goods.

Summary

The conditions that have prevented U.S. immigrants from pressuring native wages may not persist in coming decades. This is because of both supply-side and demand-side considerations. Instead, a plausible case can be argued that immigration will increasingly work against the skill-upgrading of the U.S. labor force, in a way that exposes U.S. workers to developments in low-income countries.

If this happens, the political economy of immigration may shift. The larger is the impact of immigration on wages, the stronger demands for changes in the level or composition of immigration are likely to be. In section 6, we will turn to consider these political-economy issues.

4. Illegal Immigration

As we've seen, illegal aliens currently account for a large fraction (about one-third) of new immigrants in the United States. This has not always been the case. Illegal immigration arose only after the U.S. government began to restrict legal immigration in the 1920's. Except for a brief episode in the 1950's, it was small in scale until temporary immigration programs ended in the 1960's (see Figures 4.2, 4.3). While illegal immigrants come from many nations, Mexico is the single largest source country. From Table 2.4, in 1996 an estimated 54% of U.S. illegal immigrants were Mexican nationals. Over the period 1988-1998, over 95% of those apprehended by the Border Patrol attempting to enter the country illegally were individuals from Mexico (INS, 2000). Given large and persistent wage differences between the two countries, restrictive U.S. legal immigration policies, and a long shared land border whose geography complicates enforcement, high levels of illegal immigration from Mexico are hardly surprising.

In this section, we examine U.S. policies towards illegal immigration, the factors that contribute to illegal immigration, and the impact of illegal immigration on the U.S. economy. We conclude the section with a discussion of recent proposals for changing U.S. policy towards illegal immigration.

4.1 Background

Illegal immigration in the United States has its origins in the market for agricultural labor. Historically, the United States has been abundant in land and capital and scarce in labor relative to Mexico, which has helped create large wage differentials between the two countries. Production of perishable crops tends to be very labor intensive and growers of these crops in the U.S. Southwest have recruited laborers from Mexico for a century or more. Still, Mexican immigration in the United States was slow to begin. Early last century, a series of positive shocks to U.S. agriculture and negative shocks to Mexican agriculture helped start the south-to-north labor flow.

In the early 1900's, government irrigation projects, beginning with the Newlands Irrigation Act of 1902, expanded the land available for agriculture in the western United States, helping increase agricultural labor demand in the region. Shortly thereafter, the Mexican Revolution (1911-1917) pushed many Mexican peasants off their land, some of whom moved

north to escape violence and find work.²⁷ At the time, there was little enforcement of the Mexico-U.S. border and undocumented immigration was common. The 1917 Immigration Act changed this regime by imposing a literacy test and a head tax on prospective immigrants. This, in effect, made illegal the existing (and continuing) flow of labor across the border (Martin, 1998).²⁸

After World War I, as the United States tightened restrictions on immigration overall, and from non-European countries in particular, pressures for illegal immigration increased. In 1924, the U.S. Border Patrol was created to monitor national boundaries. Initially, the Border Patrol had only 450 officers to enforce both the Canadian and the Mexican borders, making effective enforcement lax. The Great Depression induced a further tightening of restrictions on legal immigration. During this period, however, illegal immigration from Mexico was relatively low, as high unemployment in the United States dissuaded many prospective Mexican workers from migrating north.

In the 1940's, labor shortages caused by World War II re-ignited Mexican immigration. To help Mexican workers enter the U.S. labor market, in 1942 the U.S. government established the Bracero Program, which granted Mexican laborers temporary permits to work in U.S. agriculture. Laborers in Mexico, or braceros, were contracted by U.S. agricultural growers to work in the United States for a single growing season, after which they were obliged to return to Mexico. In an early example of coordination between Mexico and the United States on immigration policy, the Mexican government endorsed the program, and negotiated immigration levels with the United States, appealing to the notion that an agreed-upon legal framework would protect Mexican workers from abusive treatment by U.S. employers (Martin, 1998).

Figure 4.1 shows immigration of braceros over the program's life. At its peak in 1956, 445,200 Mexican workers entered the United States. The number of Mexican workers the Border Patrol admitted each year changed according to economic conditions. Agency reports from the 1950's indicate that U.S. agricultural labor demand was a major factor in INS decisions of how many braceros to admit. When the Border Patrol launched Operation Wetback in the early

²⁷ By some estimates, between 1910 and 1930 1.5 million Mexicans, or 10% of the country's population, emigrated to the United States (Martin, 1998).

²⁸ The same year the law was enacted, the U.S. Department of Labor began to allow temporary immigration of Mexican workers, most of whom were farm laborers. They were permitted to work in the country for one year and required to carry a special identification card. Over the period 1917-1921, 50,000 to 80,000 Mexican nationals entered the United States under this program (Martin, 1998).

1950's – which raised border enforcement as a means of reducing illegal immigration– growers were allowed to more than double the number of braceros they brought into the country, largely nullifying the impact of increased enforcement on the U.S. supply of manual labor (Calavita, 1992).²⁹

Not surprisingly, large-scale temporary immigration was controversial in the United States. Labor groups condemned the Bracero Program, and prevented temporary Mexican workers from joining U.S. unions. U.S. agricultural growers defended temporary immigration, claiming that the braceros would take jobs that American workers would not. The mechanization of U.S. agriculture gradually reduced the intensity of production in manual labor, helping weaken support for admitting braceros (Martin, 1998). The U.S. Congress abolished the program in 1964.

Since the end of the Bracero Program, the formerly legal and temporary labor inflow from Mexico has become illegal and more permanent. Many Mexican illegal aliens in the United States return to Mexico one or more times a year (Cornelius, 1982; Reyes, 1997). The number of illegal aliens living in the United States, about half of whom are Mexican, has increased steadily over time, from 2.7 million in 1987 to 5.3 million in 1997 (Warren, 1999). The annual inflow of illegal immigrants is difficult to measure directly.³⁰ One indirect measure is apprehensions by the INS of individuals attempting to enter the country illegally. While apprehensions overstate illegal immigration, since a given individual may be apprehended multiple times in a given year, its variation over time appears to reflect variation in attempts at illegal entry.³¹

Figure 4.2 shows total apprehensions by the INS and apprehensions by the Border Patrol border for the period 1931-1999. Since 1986, when the Immigration Reform and Control Act (IRCA) was passed, apprehensions by the Border Patrol have accounted for 95% of total INS annual apprehensions, with over 95% of Border Patrol apprehensions occurring at or near the Mexico-U.S. border. Apprehensions show a strong upward trend, rising from an average of 133,000 per year in the 1960's to 1.4 million per year in the 1990's. There are spikes in the series

²⁹ Operation Wetback was a response, in part, to increasing illegal immigration of individuals attempting to avoid restrictions imposed by the Bracero Program. In order to obtain jobs as braceros, Mexican workers often had to pay bribes to recruitment officers in Mexico and the United States. By entering the United States illegally workers were able to avoid these bribes. During the early years of the Bracero Program, enforcement of the border was weak. By increasing both border enforcement and the number of braceros admitted, the United States effectively legalized the flow of labor across the border (Martin, 1998).

³⁰ A large literature estimates the number of illegal immigrants and their inflow in the United States. See Hans Johnson (1997) for recent estimates for California and a discussion of other estimates. See the Mexico-United States Binational Migration Study (1998) for estimates of illegal aliens from Mexico, in particular.

during economic crises in Mexico, such as the onset of the Latin American debt crisis in 1982 and the collapse of the Mexican peso in 1994-1995, and increases in U.S. border enforcement, as occurred following Operation Wetback in 1953, the passage of IRCA in 1986, and special operations by the U.S. Border Patrol in the 1990's.

Being apprehended by the INS does not prevent an individual from attempting to enter the United States again in the near future. Individuals that the INS apprehends who agree to be deported voluntarily are not processed by the U.S. justice system, spend a few days or less in custody before being returned to their home country, and face no restrictions on their ability to enter the United States legally in the future. For Mexican nationals, voluntary deportation often involves little more than a bus ride across the border. During the 1990's, voluntary departures accounted for over 95% of all INS apprehensions.³²

To help translate apprehensions data into the net inflow of illegal immigrants, Warren (1995) estimates that for 1982-1988 the average annual net inflow of illegal immigrants from Mexico was 165,000 individuals and the INS (1998) estimates that for 1988-1996 it was 150,000 individuals. Legal Mexican immigration in the United States has risen over time, but remains at lower levels. Discounting the amnesty granted to illegal aliens as part of IRCA (see Figure 2.1), over the period 1980-1998 legal admissions of Mexican nationals by the INS averaged 86,000 individuals per year (INS, 2000).

4.2 U.S. Policy towards Illegal Immigration

Many government policies affect the flow of illegal immigrants into the United States. Some, such as setting quotas for legal immigration or denying immigrants access to public assistance, operate indirectly by affecting the expected rewards from attempted illegal immigration. Others, including the enforcement of U.S. borders and the monitoring of hiring practices by U.S. employers, affect inflows of illegal immigrants more directly. In this subsection, we focus on these direct policies, which fall under the control of the federal government, and in particular the INS. While immigration quotas and public assistance change slowly over time – typically requiring congressional action – the intensity of border enforcement

³¹ Espenshade (1994) estimates that the correlation between apprehensions and the gross flow of illegal immigrants across the Mexico-U.S. border is 0.9.

³² Those who do not depart voluntarily are subject to a hearing before a judge. If they are found to have entered the country unlawfully, they may face a bar of up to 20 years before being able to enter the United States legally (INS, 2000).

and employer monitoring are policy instruments that the INS can, in principle, change continuously. Despite federal control over enforcement policy, INS activities often give the appearance of being set on a region-by-region basis, without obvious attempts at national coordination.³³ The variation in enforcement, we shall see, is indicative of both the impact of enforcement on illegal immigration and which factors influence U.S. policies on illegal immigration.

To gauge U.S. efforts to block illegal immigration, Figure 4.3 shows federal government outlays on enforcement by the INS. INS enforcement spending has increased dramatically over time, more than doubling in real terms in the 1990's. INS enforcement activities include Border Patrol operations, inspections at U.S. points of entry, detaining and deporting apprehended aliens, and investigating those suspected of hiring illegal aliens or smuggling aliens, narcotics, or other contraband.³⁴ In 2000, of the 23,000 INS employees dedicated to enforcement, 48% worked for the Border Patrol, 24% worked in inspection, 16% were responsible for detention and deportation, and 12% were responsible for investigations. Relative to its other major activities, the INS devotes few resources to monitoring employers.

Border Enforcement. The level of border enforcement in the United States is the result of several governmental decisions. The U.S. Congress appropriates funds for the U.S. Border Patrol, as part of the overall appropriation to the INS. This appropriation specifies how the funds are to be spent, including what portion of the budget to dedicate to enforcement activities. Given the overall enforcement budget, the INS decides how to divide resources between enforcement of U.S. borders, which consists of policing land borders and ports of entry, or so-called "linewatch"

³³ A lack of coordinated enforcement policies is evident not just within the INS but between the INS and other agencies. For instance, the Border Patrol has installed license-plate readers at about one-third of the 31 border crossing points in the southwestern United States. These readers are connected to a large data bank, which allows the Border Patrol to identify stolen vehicles that are being taken out of the United States (presumably to be resold in Mexico). Approximately 2,000 stolen vehicles are identified leaving San Diego each year, alone. Due to the absence of coordination with local police agencies, little, if any, effort is made to stop the illegal export of stolen autos. See "Customs Officials Spot Stolen Cars but Don't Try to Stop Them," *New York Times*, February 25, 2001, p. 15.

³⁴ U.S. immigration law involves the INS in the detention and incarceration of foreign-born criminals. If a foreign-born individual is found guilty of having committed a crime, then the INS determines whether this individual is deportable. Cause for deportation include having entered the United States unlawfully, having committed an aggravated felony, having engaged in activities deemed contrary to the security of the United States, or having committed certain other crimes. Recent changes in U.S. immigration law have greatly expanded the set of deportable offenses. If an individual is deemed deportable, then the INS forcibly "removes" the person from the country, usually after the individual has finished his or her prison sentence. The number of aliens removed for criminal violations (besides unlawful entry) increased from 2,000 in 1986 to 55,000 in 1998 (INS, 2000). Butcher and Piehl (2000) find that criminals subject to deportation by the INS tend to serve longer prison sentences than either native-born prisoners or foreign-born prisoners not subject to deportation. They also find that relative to native-born inmates, foreign-born prison inmates are much more likely to have been convicted of a drug-related offense.

duty, and internal enforcement, which consists of manning traffic checkpoints, conducting raids on worksites, and investigating employers suspected of hiring illegal aliens.

The Border Patrol concentrates the majority of its enforcement efforts on the Mexico-U.S. border. From 1970 forward, 57% of total Border Patrol officer hours were devoted to linewatch duty and 91% of linewatch officer hours occurred at the U.S.-Mexico border. With this allocation of enforcement activities, it is not surprising that most apprehensions occur at or near the Mexico-U.S. border. Since 1970, 93% of apprehensions occurred in the U.S.-Mexico border region and 60% occurred as individuals were attempting to cross the border itself.

IRCA and subsequent legislation mandated increases in border enforcement. The INS has implemented these initiatives largely by raising enforcement at specific points along the border where attempts at illegal entry appear to be heaviest.³⁵ Figures 4.4a and 4.5a show border apprehensions and total manhours Border Patrol officers spend policing the border by month in Arizona, California, and Texas.³⁶ Figures 4.4b and 4.5b show these same data for specific regions inside these states, which have historically accounted for most illegal entry.³⁷ For the period 1980 to 1993, when the first of the Border Patrol special operations began, California and Texas accounted for 54% and 36% of border apprehensions and 34% and 48% of border enforcement hours, respectively. Within these states, two cities, San Diego and El Paso, were the most active crossing points for illegal aliens, accounting for 50% and 20% of total apprehensions and 27% and 15% of total enforcement hours over the 1980-1993 period.

Border Patrol special operations appear to have reduced illegal entry at specific crossing points, without necessarily curtailing illegal immigration overall. The first major initiative, “Operation Hold the Line,” was launched in El Paso, in late 1993 (as indicated by the first solid vertical line in Figures 4.4b and 4.5b). Within a three-month period, the Border Patrol more than doubled officer patrol hours in and around the city. The effects on attempted illegal immigration are apparent in the apprehensions data for Texas in Figures 4.4a and 4.4b. Within six months of stepping up enforcement, apprehensions in El Paso fell from 15,000 per month to 4,000 per month, as many migrants stopped using the city as a U.S. entry point (Bean et al. 1994).

³⁵ In addition to increasing enforcement office hours, as documented below, the Border Patrol has also installed walls, fences, and underground sensors along the border, and acquired high-tech surveillance equipment.

³⁶ Apprehension figures are seasonally adjusted (by subtracting off the monthly mean and adding in the sample mean).

³⁷ The Border Patrol organizes its enforcement activities in the United States according to geographic sector. From West to East, the nine sectors along the Mexico-U.S. border are San Diego and El Centro in California; Yuma and Tucson in Arizona; and El Paso, Marfa, Del Rio, Laredo, and McAllen in Texas.

In Figures 4.5a and 4.5b it is clear that at the moment the Border Patrol raised enforcement in El Paso, it did *not* raise enforcement elsewhere. Not surprisingly, many migrants moved west and began to enter the United States through Arizona (Cornelius, 2000). In the year after Operation Hold the Line began, apprehensions in Tucson, Arizona more than doubled from, after having been stable for over a decade.³⁸ While apprehensions declined in El Paso, they did not decline for the border overall, resulting in a fall in the city's share of total apprehensions from 22% in 1992 to 7% in 1994. Had the Border Patrol been intent on reducing illegal immigration along the border as a whole, one might have expected the agency to have complemented its efforts in El Paso by stepping up enforcement at other major crossing points. But it was not until the late 1990's that Border Patrol responded to the changing crossing patterns of illegal migrants by increasing enforcement in Arizona.³⁹

The next major border enforcement initiative, "Operation Gatekeeper," began in San Diego in 1995 (as indicated by the second vertical line in Figures 4.4b and 4.5b). Between the middle of 1994 and the end of 1995, the Border Patrol more than doubled office patrol hours in San Diego and built steel barriers along the border where the city adjoins Tijuana. Between 1995 and 1998, the Border Patrol increased enforcement hours in the region by another 50%.⁴⁰ In 1995, apprehensions in San Diego first rose and then fell sharply, as illegal migrants began to stop using the city as a crossing point. At the same time, apprehensions jumped dramatically in El Centro (in eastern California) and in Arizona.⁴¹ Again, overall border apprehensions did not decline. San Diego's share of all border apprehensions simply fell from 53% in 1994 to 20% in 1998. As with Operation Hold the Line, migrants reacted to Operation Gatekeeper by changing the points at which they crossed the border. In the late 1990's, the Border Patrol responded to these changing crossing patterns by increasing enforcement in eastern California and Arizona, but this came several years after it had raised enforcement in San Diego.

The practice of raising enforcement at one location but not others affects *where* illegal immigrants cross the border but not necessarily *how many* cross. Figure 4.2 shows that total

³⁸ This has led, not surprisingly, to an increase in illegal immigrants residing in Arizona. The INS estimates that the Mexican illegal alien population in Arizona increased from 115,000 in 1995 to 400,000 in 2000. See Michael Jonafsky, "Phoenix Counts its Many Challenges: Illegal Immigration, Unrelenting, Has Put a Strain on Services," *New York Times*, April 11, 2001, p. A12.

³⁹ In the late 1990's, the Border Patrol launched two new special enforcement initiatives, Operation Safeguard in Arizona, and, Operation Rio Grande in south Texas.

⁴⁰ This increase occurred as the Border Patrol expanded Operation Gatekeeper into Eastern California and Arizona.

⁴¹ The disadvantage to crossing in Arizona is that the natural environment is harsh. The Sonoran desert, which extends from Mexico into southern Arizona, has freezing temperatures in Winter and scorching temperatures in Summer. In the last decade, approximately 600 individuals have died attempting to cross the border (Cornelius,2000).

border apprehensions, as an indication of attempted illegal immigration, increased in the 1990's. Warren (1995, 1999) estimates that from the late 1980's to the mid 1990's the average annual inflow of illegal aliens from Mexico was steady at 150,000 to 165,000 individuals per year.⁴² Between 1988 and 1997, on net 1.3 million new illegal immigrants from Mexico entered the United States.

The Border Patrol strategy of targeting enforcement in specific regions may serve to appease groups opposed to illegal immigration, such as residents of large border cities like El Paso and San Diego,⁴³ without disrupting industries intensive in manual labor (by shutting down illegal immigration entirely). As one San Diego resident characterized Operation Gatekeeper, "It's great for San Diego – people don't have illegal aliens traipsing through their yards and littering, but of course they are all being pushed elsewhere."⁴⁴ The INS is, directly or indirectly, subject to political pressure from groups that favor lax enforcement, including agricultural growers in the western U.S. states that specialize in labor-intensive, perishable crops. Growers frequently declare that without low-wage foreign labor they would be forced to cut back production or shutdown altogether. In defense of hiring illegal aliens, one California grower declared, "The reality is that if the government was able to stop everybody at the border, there would be no agriculture. You wouldn't be eating asparagus."⁴⁵

In the current, highly politicized environment, it is difficult to document overt attempts by interest groups to undermine border enforcement. Historical evidence of anti-enforcement efforts, however, is abundant.⁴⁶ Calavita (1992) finds that in the 1940s and 1950s the district commissioner of the U.S. Border Patrol in El Paso would routinely issue orders to stop apprehending illegal immigrants during the agricultural harvest season. During the few occasions when the Border Patrol actually did increase apprehensions, Texas farmers complained formally to their congressional representatives, who then pressured the INS publicly to cut back enforcement.

⁴² Initial estimates for 1997 to 2000 suggest that the inflow of illegal immigrants from Mexico has continued apace.

⁴³ See Marcus Stern, "La Raza Blasts Move in State to Crack Down on Illegal Immigration," *The San Diego Union-Tribune*, July 20, 1994, p. A8; Daniel B. Wood, "Can Crackdown Halt Border Crossings?" *The Los Angeles Times*, May 8, 1996, p. 4; and statement of Raul Yzaguirre, National Council of La Raza, Subcommittee on Immigration, U.S. House of Representatives, June 29, 1995.

⁴⁴ See Joe Cantlupe, "Arrests up since 1994 Crackdown at Border; Costly Effort Fails to Deter Illegal Flow," *San Diego Union-Tribune*, February 20, 2001.

⁴⁵ Denny Walsh, "Valley Grower Guilty: Admits Farm Used Illegal Workers," *The Sacramento Bee*, April 30, 1999.

⁴⁶ This influence has infuriated politicians sympathetic to organized labor. In 1952, Senator Hubert Humphrey of Minnesota lamented, "Because of the economic interests that are involved in the wetback problem, no real, sincere effort has been made to solve it. As long as it is possible to hire the wetbacks at 10 cents an hour, they will be coming across the border until kingdom come" (Calavita, 1992: 37).

One is left with the impression that, whether intended or not, border enforcement in the United States is designed to work, just not very well. That said, the INS has raised total border enforcement substantially in the last 15 years. Though it appears not to have coordinated the timing of its operations at different points along the border, by 2001 it had raised enforcement at most major crossing points. It remains to be seen whether these increased enforcement efforts will reduce illegal immigration.

Interior Enforcement. As already noted, relative to border enforcement the INS devotes few resources to investigating or monitoring employers that hire or appear likely to hire illegal immigrants. In 1990, less than eight percent of INS enforcement manpower was devoted to worksite inspections (Juffras, 1991). Table 4.1 shows Border Patrol apprehensions of Mexican nationals by the type of activity illegal aliens were engaged in at the time of apprehension. Of the 1.5 million apprehensions the Border Patrol made in 1998, fewer than 10,000 occurred at U.S. farms or other worksites.⁴⁷ As we've seen, most apprehensions occurred at or near the border. The low level of worksite apprehensions is surprising, perhaps, given that in 1996 more than two-thirds of the 2 million Mexican illegal aliens resided in U.S. states bordering Mexico (INS, 1998), with a large fraction of these individuals living and working near the actual border.

Viewed in terms of efficiency, the strategy of favoring border enforcement over interior enforcement may seem puzzling. It is difficult to detain illegal immigrants as they cross somewhere along the 2,000 mile U.S.-Mexico border, but it is relatively easy to do so at many places of work, especially during peak production periods, such as agricultural fields at harvest time or apparel factories prior to the annual pre-Christmas production boom. One interpretation of this enforcement strategy is that the INS is pressured by one means or another to avoid enforcement activities that directly injure specific U.S. parties, such as agricultural growers or factory owners.

Periodic attempts by the INS to increase interior enforcement are often met with stern political opposition. Following INS raids of onion fields in the state of Georgia during the 1998 harvest, the U.S. Attorney General, both Georgia senators, and three Georgia congressional representatives publicly criticized the INS for injuring Georgia farmers.⁴⁸ The raids ceased shortly thereafter. Similar raids of farms in California, Florida, or Texas, which are home to the

⁴⁷ Low worksite apprehensions do not reflect any legal mandate of the Border Patrol to focus enforcement on the actual border. The agency's jurisdiction includes interior regions proximate to U.S. borders.

largest concentrations of undocumented workers are very rare. This may be due to the political strength of agricultural interests in these states. Similarly, the INS recently investigated the meat-packing industry in Nebraska and Iowa, which is reputed to use illegal labor intensively, but made no large-scale raids on any plants. Most plant visits by INS agents were announced in advance.⁴⁹ In defense of the inaction an INS official stated, “We don’t want to have a negative impact on the production capabilities of these companies.”⁵⁰

A further constraint on interior enforcement efforts by the INS has been that until recently employers faced few penalties for hiring illegal immigrants. Prior to IRCA in 1986 it was not explicitly illegal to hire undocumented workers. Though it was illegal to “harbor” illegal immigrants, under the so-called Texas Proviso of 1951 employment was not interpreted legally as harboring. Agricultural political interests appear to have been instrumental in getting the Texas Proviso adopted (Calavita, 1992).

While IRCA did institute penalties for employers that hire undocumented workers, sanctions are infrequent and appear to have little bite. Table 4.2 shows INS investigations of employers suspected of hiring illegal aliens and the number of cases in which it issued warnings or notices of intent to fine, or imposed actual sanctions. During the period 1992-1998, the INS investigated 5,000 to 8,000 employers per year. The agency fined relatively few employers, ranging from a low of 235 in 1998 to a high of 799 in 1993. In no year were more than 20 employers fined in excess of \$20,000 and only one fine collected over the entire period exceeded \$185,000 (<http://www.cis.org>).

Temporary Immigration. One alternative to illegal immigration is temporary immigration of low-skilled workers, as occurred under the Bracero Program. Current U.S. law allows for such temporary immigration, but only on a small scale. In 1998, the INS granted temporary work visas to 27,000 agricultural workers and 25,000 low-skilled, non-agricultural workers (INS, 2000).⁵¹ Nearly all agricultural workers and most non-agricultural are from either Mexico or the

⁴⁸ See Mark Krikorian, “Lured by Jobs, Illegal Immigrants Risk Death at Border Crossings,” *Santa Barbara News-Press*, April 25, 1999.

⁴⁹ The INS strategy was to announce plant visits, ask employers for permission to review employee records, and then to interview workers whose records looked suspicious. The many workers who failed to report for their INS interviews lost their jobs. The result of the INS investigation, then, was not monetary sanctions on employers but (indirectly) forced quits by workers. See “Immigration: In the Vanguard,” *Economist*, October 16, 1999, pp. 31-32.

⁵⁰ Barbara Hagenbaugh, “US, Meatpackers Make Deal on Immigration Crackdown,” Reuters, May 7, 1999.

⁵¹ The H-2 visa applies to temporary immigrants working in low-skill occupations. Agricultural workers enter under H-2A visas and non-agricultural workers enter under H-2B visas. Temporary work visas are also granted to individuals in high-skill occupations or who have demonstrated extraordinary abilities (see note 2).

Caribbean.⁵² To obtain a temporary work visa on behalf of an employee, employers have to demonstrate that no U.S. workers would be displaced by admitting the foreign worker. This restriction appears to account for why the program is little used in practice.

Current provisions for the temporary immigration of farm workers were a result of IRCA. IRCA permitted undocumented agricultural workers in the United States to qualify as special agricultural workers (SAWs), which gave them legal resident status. It also allowed farmers to bring in temporary, undocumented laborers as replenishment agricultural workers (RAWs), subject to government approval. Provisions for SAWs and RAWs appeared to be necessary to convince agricultural interests to support passage of IRCA. They initially opposed the legislation due to its provisions for sanctioning employers that hired illegal aliens (Martin, 1990).

Recently, there have been attempts by U.S. congressional representatives from agricultural states to pass legislation that would greatly expand the guest-worker program. Current proposals would increase temporary immigration to 250,000 workers a year. The Mexican government has publicly supported this initiative. Allowing temporary emigration generates export earnings for Mexico and potentially allows the country to retain workers with U.S. job experience. It appears that any policy change would be coupled with an amnesty for illegal immigrants currently in the United States. Until now, passage of a new large-scale temporary immigration program has been unable to surmount strong opposition from labor unions such as the AFL-CIO.⁵³

4.3 Factors that Contribute to Illegal Immigration

As we have discussed, current U.S. policy on illegal immigration is based largely on border enforcement, though the U.S. government is contemplating proposals to augment this policy with large-scale temporary immigration of low-skilled guest workers. To consider how these policies might influence U.S. immigration and the U.S. economy, we turn to recent academic research on the determinants of illegal immigration and the impact of illegal immigration on the U.S. economy. Research on these subjects is complicated by the absence of

⁵² In 1998, of the 27,308 H-2A visas granted, 21,594 went to individuals from Mexico and 4,277 went to individuals from Jamaica; and of the 24,895 H-2B visas granted, 10,727 went to individuals from Mexico, 4,293 went to individuals from Canada, 2,583 went to individuals from Jamaica, 1,678 went to individuals from Europe (largest source country being the United Kingdom), 2,460 went to individuals from Asia (largest source country being China), and 1,799 went to individuals from Central and South America (largest source country being Guatemala) (INS, 2000).

⁵³ There have been several recent, unsuccessful attempts to re-instate temporary immigration. The most recent failed initiative was in 1996 (Martin, 1998).

direct data on illegal immigrants. In the literature, researchers compensate through one of three strategies: by using data on apprehensions and enforcement at the Mexico-U.S. border, by using U.S. census data on recent Mexican immigrants (a slight majority of whom appear to be in the country illegally), or by performing case studies of communities that send or receive large numbers of illegal immigrants.⁵⁴ We organize the discussion around the main findings in the literature.

Over time, the population of illegal immigrants has shifted away from itinerant agricultural workers towards more permanently settled urban workers. The characteristics of the illegal immigrant population in the United States are difficult to estimate precisely, since these individuals naturally tend to hide their immigration status. The available evidence is drawn from surveys in specific U.S. or Mexican communities and data from the U.S. population census on individuals recently arrived from Mexico.

In the 1950's and 1960's, most illegal immigrants appeared to have a profile similar to workers admitted under the Bracero Program: they were primarily young males from rural, Western Mexico coming to the United States to work in agriculture for a single growing season, after which they would return home (perhaps to migrate again the following year) (Cornelius, 1992; Reyes, 1997). Since then, the population of recently arrived Mexican immigrants in the United States has become more heterogeneous, in particular, becoming more female, more educated, less-oriented agriculture, more likely to be from urban areas in Mexico and to reside in urban areas in the United States, and more likely to be living with family members (Cornelius, 1992; Massey, Goldring, and Durand, 1994; Borjas, 1996; Bustamante et al, 1998; Cornelius and Marselli, 2001; Durand, Massey, and Zenteno, 2001). Living with family members in the United States is notable, as it tends to reflect long-term settlement.

These changes in immigrant characteristics in part reflect changes in Mexico's population. Since the 1960's, Mexico has become a more urban, less agricultural economy with higher rates of female labor-force participation. They also reflect changes in U.S. labor demand. Western U.S. states, where most illegal immigrants settle, have grown substantially in the last four decades, increasing demand for low-wage manual labor in a wide array of service and manufacturing activities. Urban workers tend not to face the seasonal lulls in labor demand that are characteristic of agriculture, allowing them to establish a more permanent residence.

⁵⁴ For surveys on recent literature on illegal immigration, see Durand and Massey (1992) and Espenshade (1995).

There appear to be sharp differences among individuals in Mexico in terms of who migrates and who does not. Comparing Mexican adults who have returned from migrating to the United States to Mexican adults who have never migrated (in a sample of rural Mexican communities), migrants are on average much younger (indicating more recent cohorts are more likely to migrate), more likely to have started or finished primary school but less likely to have finished secondary school (indicating migrants are more likely to have moderate but not high levels of education), and much more likely to have relatives who have also migrated to the United States (Orrenius and Zavodny, 2001). The importance of relatives suggests that family networks influence migration decisions. Families provide a U.S. support base, which may help immigrants assimilate. This may lower the uncertainty associated with immigration, especially for illegal aliens who are likely to be wary of using formal channels to search for jobs or housing.

Illegal immigration appears to be highly sensitive to changes in Mexican wages and moderately sensitive to changes in U.S. wages. Hanson and Spilimbergo (1999), building on earlier work by Bean et al. (1990) and Borjas, Freeman, and Lang (1991), use apprehensions at the Mexico-U.S. border as a proxy for attempted illegal immigration from Mexico and examine how border apprehensions respond to changes in Mexican wages, U.S. wages, border enforcement, and other factors. Changes in Mexican wages have a dramatic effect on border apprehensions. A 10% decline in Mexican wages leads to a 6-8% percent increase in attempted illegal immigration from Mexico. Over the past three decades, Mexico has experienced wide variation in real wages, as periodic devaluations of the peso have led to bursts of inflation, which have caused real wages to fall sharply. These real wage declines have been followed by surges in attempted illegal entry. Figure 4.6 plots log border apprehensions against log average hourly real wages for production workers in Mexican manufacturing. Apprehensions rise as Mexican wages fall, indicating that volatility in Mexican wages contribute to illegal immigration. Much research on inter-regional migration in the United States and elsewhere finds that it is labor earnings in the receiving region, and not the sending region, that matter for migration flows (e.g., Shaw, 1986). This does not appear to be the case in Mexico, where low and volatile wages are a strong push factor for illegal migration.

Border apprehensions are positively correlated with U.S. wages. This is true for U.S. wages expressed both in peso terms and in dollar terms. That border apprehensions rise when the purchasing power of U.S. wages in Mexico rises is consistent with the fact that Mexican

immigrants in the United States remit a substantial portion of their labor earnings to family members and others in Mexico.⁵⁵ In deciding to migrate illegally to the United States, immigrants appear to count on supporting family members in Mexico or returning to Mexico eventually. Other factors one might expect would be associated with illegal immigration, such as unemployment in the United States (or in U.S. border states) or minimum wages in Mexico and the United States, are only weakly correlated with border apprehensions. While some of these factors may matter in long run, they do not matter for changes in illegal immigration at monthly frequencies.

There is mixed evidence about whether border enforcement reduces illegal immigration. Border enforcement does not eliminate illegal border crossings. It does, in many cases, force migrants to make multiple attempts at crossing the border before they succeed in evading the Border Patrol (Espenshade, 1994). Each time a migrant is caught, he or she is detained and sent back across the border, usually within a few days. This allows the migrant to make two or more attempts at illegal entry within a period as short as a week. Of migrants who had illegally entered the United States one or more times and then returned to Mexico, Kossoudji (1992) finds that on a given trip to the United States in the late 1970's 25% to 40% were apprehended. Also using data on repeat migrants gathered in Mexico, Massey and Singer (1995) estimate the probability of apprehension for any given trip in the 1970's and 1980's to be 35%.⁵⁶ To improve the likelihood of successful entry, a migrant may choose to cross the border at remote locations, such as in the Arizona desert. This brings with it greater risks of physical injury or even death (Cornelius, 2000). Another option is to hire the services of a smuggler, known as a coyote, for help in crossing the border.⁵⁷

There is considerable debate about the effectiveness of border enforcement, due in part to the fact that its total effect on illegal immigration is difficult to observe. Border enforcement affects illegal immigration directly, in that more enforcement means fewer attempts to cross the

⁵⁵ In the early 1990's remittances (income migrants earned abroad and sent home) totaled 10% of Mexico's export earnings (Durand, 1996). They rose from \$2.5 billion in 1990 to \$5.6 billion in 1998 (Woodruff and Zenteno, 2001).

⁵⁶ Using the same data as Massey and Singer, but focusing on a three-year period following implementation of IRCA, Donato, Durand, and Massey (1992) estimate the apprehension probability to be 40% to 60%.

⁵⁷ Coyotes offer a variety of services, ranging from transport immediately across the border to transport to a city in the U.S. interior and the provision of fake U.S. documents (Donato, Durand, and Massey, 1992). Crane et al. (1990) report that among individuals apprehended by the INS in 1993 8% had used a coyote, compared to 5% in 1988 and 15% in 1976. For individuals in Mexico, the price of coyote services appears to vary from a few hundred dollars to a few thousand dollars, depending on the type of service the coyote provides and on the current state of border enforcement. Prior to Operation Gatekeeper in San Diego, coyotes charged about \$300 for assistance in crossing the border and transportation to Los Angeles. By the late 1990's, these fees had risen to \$800 to \$1,500.

border illegally on a given day are successful. This direct effect is abundantly clear in the data. Hanson and Spilimbergo (1999) find that the elasticity of apprehensions with respect to enforcement is approximately 0.8 to 1.0, which means that a 10% increase in border enforcement produces an 8% to 10% increase in border apprehensions.⁵⁸ More apprehensions do not necessarily mean less illegal immigration, as migrants may respond to greater enforcement by increasing the number of attempts they make to enter the United States illegally.

The indirect effects of border enforcement are harder to observe. Enforcement may have a deterrent effect, in that higher enforcement – by raising the costs of entering the United States – may reduce the number of individuals that attempt to cross the border. The INS cites the success of its special operations as evidence of such a deterrent effect. While apprehensions do fall at locations where the Border Patrol has stepped up enforcement (indicating fewer attempts to cross the border), they later rise at other locations, casting doubt of the presence of border-wide deterrence. Further, as we've seen there is no clear evidence that the net inflow of Mexican illegal immigrants has fallen much following the recent large increases in border enforcement.

Greater enforcement may change the border-crossing behavior of illegal immigrants, without having much of an effect on the number of illegal aliens that enter the country on net. When the INS increases enforcement, migrants who prefer to return to Mexico one or more times a year may simply reduce the number of these trips. Consistent with this idea, Kossoudji (1992) finds that after being apprehended illegal Mexican migrants who move back and forth between Mexico and the United States tend to stay in the United States longer on each trip and to make fewer return trips to Mexico. If migrants respond to a higher risk of apprehension by reducing their return trips to Mexico, greater enforcement may have the perverse effect of making the illegal immigrant population in the United States more permanent.

There is some evidence that greater enforcement changes the composition of individuals who cross the border. Orrenius and Zavodny (2001) find that for a sample of young males in rural Mexican communities greater border enforcement reduces the likelihood of migrating to the United States among those with very low education levels (zero to five years of schooling) but not among those with higher education levels. Higher enforcement raises the costs of crossing

Similarly, as the INS increased border enforcement in Arizona, coyote fees for transportation from Agua Prieta (across the border from Douglas, AZ) to Phoenix rose from \$150 in 1999 to \$800 to \$1,300 in 2000 (Cornelius, 2000).

⁵⁸ These elasticities are based on instrumental-variables estimates of the impact of enforcement on apprehensions. An elasticity that is less than one implies there are diminishing returns to border enforcement. These diminishing returns are evident in the

the border – which an individual may incur directly by paying higher fees to coyotes or indirectly by having to spend more time and energy crossing the border – and individuals with low education levels may be unable to incur these extra costs. These results suggest it is conceivable that higher enforcement raises the skill profile of illegal immigrants in the United States.

Changes in enforcement of U.S. borders against illegal immigration do not affect wage outcomes for workers in U.S. border regions. One important question is whether border enforcement – by changing the level or location of illegal entry – affects the U.S. regional economies in which immigrants settle. Hanson, Robertson, and Spilimbergo (2001) examine the impact of border enforcement on wages in border regions of the United States and Mexico. As most illegal immigrants embark from a Mexican border city and choose a U.S. border state as their final destination, they examine the border regions of California, Texas, and Mexico. If enforcement impedes illegal immigration and if illegal immigrants depress wages in the regions in which they settle, then wages in border regions will tend to rise after an increase in enforcement.

For high-immigrant industries (apparel, textiles, food products, furniture) in California and Texas, there is zero correlation between wages and enforcement of the Mexico-U.S. border in that state. There is also no evidence of a positive effect of border enforcement on the wages of workers with low-education levels (high-school dropouts, high-school graduates) in border regions of California or Texas.⁵⁹ For Mexico, the impact of U.S. border enforcement is larger. There is a moderate negative impact of border enforcement on wages for low-education workers (six years of education or less) in Tijuana, which is the most active crossing point for illegal immigrants during the sample period. This is consistent with higher U.S. border enforcement increasing the supply of low-wage workers looking for jobs in Tijuana.

That border enforcement has small U.S. wage effects suggests that illegal immigration may not depress wages in U.S. border labor markets. This interpretation is consistent with the absence of regional wages effects for immigration overall, as discussed in section 3, and with the

data. As the INS has increased border enforcement, the number of apprehensions the Border Patrol yields per hour spent policing the border has declined from 0.29 in the 1980's to 0.24 in the 1990's.

⁵⁹ Both sets of results remain true even after instrumenting for border enforcement (since the INS may set enforcement in response to economic conditions in U.S. or Mexican border areas) using data on U.S. political cycles and activity at other U.S. international boundaries (ports and Canadian border crossings).

existence of labor-market institutions that help illegal immigrants rapidly find work in the United States.⁶⁰

Border enforcement appears to be sensitive to political pressure from industry. Lax employer monitoring by the INS is indirect evidence that political factors influence the intensity with which the U.S. government enforces against illegal immigration. Hanson and Spilimbergo (2001) search for more systematic evidence of such effects. They examine whether sectoral shocks influence U.S. border enforcement in order to see whether border enforcement is correlated with the fortunes of industries that use illegal immigrants most intensively. Political lobbying is one mechanism that could create such a correlation. As open lobbying *in favor* of illegal immigration is unlikely, they look for factors that affect the economic return to lobbying on border enforcement and see whether these factors are correlated with changes in enforcement activities.

To motivate this analysis, consider the apparel industry, which is a major employer of illegal immigrants. To guarantee a supply of undocumented workers, apparel firms may lobby the government to maintain weak border enforcement. Opposing these efforts, labor unions and other groups may pressure the government to keep illegal immigrants out. Out of this situation emerges an equilibrium level of enforcement. Now, suppose there is a positive shock to apparel demand. This shock raises the apparel industry's demand for illegal labor, as well as the return to lobbying for lower enforcement, resulting in a lower equilibrium level of border enforcement.

Hanson and Spilimbergo (2001) estimate the sensitivity of border enforcement to relative price changes in industries that use undocumented workers intensively (apparel, perishable fruits and vegetables, slaughtered livestock, construction). Controlling for general economic conditions in the United States and Mexico, they find that increases in the relative product price (or capacity utilization rate) for an immigrant-intensive industry today is associated with a *decrease* in border enforcement 6 to 10 months in the future. This suggests that authorities relax enforcement when the demand for undocumented workers increases. Border enforcement also rises when overall labor-market conditions in the United States tighten, which suggests that the U.S. government raises enforcement when attempted illegal immigration is expected to be high. It appears, then, that enforcement softens when specific sectors that use illegal aliens intensively expand but not when the overall demand for labor is high. This is consistent with free-rider

⁶⁰ For evidence on labor-market integration between the United States and Mexico, see Robertson (2000).

problems in special interest group activity, in which sectors that benefit greatly from lower border enforcement, such as apparel and agriculture, lobby heavily on the issue while remaining sectors that benefit modestly are politically inactive.

4.4 Summary and Policy Issues

Since the end of large-scale temporary immigration programs in the 1960's, illegal immigration in the United States has increased dramatically. About half of U.S. illegal aliens are from Mexico and enter the country by crossing the Southwest U.S. border illegally. Illegal immigration surges during economic downturns in Mexico, which have occurred with an unfortunately high frequency over the last two decades. The U.S. government attempts to impede illegal immigration mainly by policing borders and public spaces in border regions, where illegal immigrants tend to congregate, and by monitoring U.S. employers. These enforcement efforts have been inconsistent across time and space and appear not to have reduced noticeably the annual inflow of illegal aliens. The U.S. government devotes relatively little energy to employer monitoring and often seems reluctant to apply laws banning the employment of illegal aliens.

If the United States intends to reduce illegal immigration sharply in the future, it has three broad policy options: intensify border enforcement, increase employer monitoring and sanctions against those found to hire illegal aliens, or attempt to replace illegal immigration with the large-scale temporary immigration of low-skilled guest workers (coupled with current enforcement policies).

The get-tough border enforcement policies of the 1990's succeeded in reducing illegal entry at certain active crossing points but have yet to produce a noticeable reduction in net inflows of illegal aliens. Perhaps the clearest evidence of this lack of success is that apprehensions continue to rise with enforcement. Were the new high levels of border enforcement a sufficient deterrent, attempts at illegal immigration would fall, but they have not. To curtail illegal immigration from Mexico may require a much larger enforcement effort, through an expanded Border Patrol or other security presence. If past events are any guide, a large security presence on the border would face strong political opposition from residents of border regions, agriculturalists and other employers in industries that depend on manual labor, and the Mexican government.⁶¹

⁶¹ To date, Pat Buchanan is the only politician of note to have proposed an expansive security presence on the border.

The apparent failure of border enforcement to eliminate illegal immigration is not to say that the policy is completely ineffective. For many prospective migrants, the fact that the Border Patrol actively polices U.S. borders surely makes the risk of apprehension too great to warrant attempting illegal entry. It does appear, however, that those individuals who are on the margin between migrating and not migrating are relatively insensitive to changes in border enforcement. They appear to be much more responsive to fluctuations in Mexican and U.S. wages.

There is currently little discussion of increasing interior enforcement against illegal immigration. Attempts by the INS to mount extensive campaigns to locate and penalize employers of illegal aliens have been condemned by the employers themselves and often by their congressional representatives or other political actors. Few of these campaigns have produced onerous sanctions against employers.

The revealed U.S. preference for border over interior enforcement may reflect the relative political power of employer groups. While enforcement of any kind reduces the likelihood that a U.S. employer is able to hire an illegal alien, border and interior enforcement operate quite differently. For employers, the costs of border enforcement have low variance. More border enforcement simply means a lower probability of finding an illegal worker at a given wage. The costs of interior enforcement, on the other hand, have high variance, as with some probability an employer may face a very negative outcome involving fines, legal fees, and perhaps other legal repercussions. Given the option of two policies that yield the same level of illegal labor supply, we would expect employers to prefer border over interior enforcement and to advocate against interior enforcement on this basis. Current U.S. policy choices support this reasoning.

The third U.S. policy option is resuming large-scale temporary immigration. In the past, the United States has only been willing to admit large numbers of temporary immigrants during and following major wars (1917-1921, 1942-1964), which tend to be times of labor shortage. In the current environment, labor shortages have come not from war but from two apparently unrelated events: the declining labor-force participation of less-skilled native workers and a boom in high-tech industries that are intensive in engineers, computer programmers, and other high-skilled workers. Current proposals to increase temporary immigration both of college graduates in technical occupations (through H-1B visas) and of low-skilled manual laborers (through H-2A and H-2B visas) would increase U.S. labor supplies at the extremes of the skill distribution.

How would increased temporary immigration of manual laborers affect illegal immigration? Let us assume that current levels of border and interior enforcement are maintained. Let us assume also that the U.S. chooses to admit 200,000 temporary workers from Mexico per year (the current proposal is for 250,000, but we will assume that some of these quota slots get allocated to other countries), a number roughly equal to the net annual inflow of illegal aliens from Mexico (Warren, 1999). Shouldn't we expect that attempted illegal immigration would cease or at least drop off substantially?

There are at least two reasons why we may not. First, as a practical matter, though net illegal immigration from Mexico is 150,000 to 200,000 individuals per year, gross illegal immigration is much higher. As we've seen, many Mexican illegal immigrants in the United States return home one or more times a year, to spend the Christmas holidays with their families, to tend to business interests, etc. There is no reason to believe that illegal border crossings by existing illegal migrants would cease just because some fraction of new migrants received temporary work visas.

Second, and more importantly, temporary immigration and illegal immigration confer different bundles of citizenship rights. For manual laborers, a temporary work visa gives an individual the right to work in the United States for a given U.S. employer for some time period, typically up to a year in length. The worker receives no other citizenship rights and is not permitted to bring along other family members. Illegal immigration, obviously, confers no immediate citizenship rights. But in expectation illegal immigrants who succeed in staying in the United States would be eligible for any future amnesty for illegal aliens. The most recent amnesty was part of IRCA in 1986, and applied to individuals who could demonstrate that they had been in the United States continuously for a period of six years. Most proposals for expanded temporary immigration include an amnesty of some kind for long-term illegal aliens.⁶² For illegal immigrants, then, squatter's rights seem to apply – if they can remain in the United State long enough they stand a reasonable chance of gaining legal residence.

It is conceivable that for some prospective immigrants the uncertain but potentially expansive citizenship rights conferred by illegal immigration are superior to the certain but highly

⁶² Short of an all-out amnesty, illegal aliens occasionally have other options for obtaining legal residence. For instance the Legal Immigration and Family Equity Act of 2000 temporarily gave illegal immigrants the option to apply for U.S. legal residence, despite the fact that their presence in the country violates U.S. law. After paying a \$1,000 fine, an illegal alien, under certain restrictions, could file an application for legal residence without having to return to his or her country of origin. The period for filing was limited to a several month period in early 2001.

restricted citizenship rights conferred by temporary immigration. It is also conceivable that some prospective immigrants who are deterred by existing U.S. enforcement practices (e.g., those who view being apprehended and deported as an excessively harsh outcome) would find temporary immigration attractive. If these two groups are sufficiently large, then expanded temporary immigration could potentially have only a small impact on current levels of illegal immigration.

5. Fiscal Impacts of Immigration

The fiscal impact of immigration figures prominently in recent debates over U.S. immigration policy. The issue has attracted attention only recently, as the 1980's and 1990's were the first decades in which there were both large immigrant inflows and a relatively generous welfare state. During the massive immigration of the early 20th century, the social state was largely nonexistent, with the noticeable exception of public education. And in the 1960's, when the modern U.S. welfare state was created, the U.S. foreign-born population was at a historically low level and falling as a share of the total population (see Figure 1.1). The current immigration wave has occurred during a period in which the role of the welfare state per se is heavily debated. This combination of rising immigration and political conflict over welfare policy has moved the fiscal impact of immigration to the center of academic and political discussions.

The surge in immigration over the last thirty years, as described in section 2, is due in large part to recent changes in U.S. immigration policy. Before the 1960's U.S. immigration was regulated by the Immigration and Naturalization Act of 1924, which had imposed numerical limits on immigration and established a quota system based on national origin.⁶³ This system was biased in favor of Northern Europeans, implicitly limiting the number of immigrants and selecting relatively educated workers. The Immigration and Nationality Act Amendments of 1965 repealed national-origin quotas, established a seven-category preference system based on family unification and skills, and imposed a ceiling on immigration from the western hemisphere. The Refugee Act of 1980 set up systematic procedures for admitting refugees, removing them as a category from the preference system. These legislative changes helped increase the number of immigrants from developing countries, opening the doors to relatively poor workers and, in the case of refugees, poor families. The composition of immigrants has changed dramatically since 1970. As section 2 shows, the average educational gap between natives and immigrants has increased and convergence between native and immigrant wages has slowed.

In 1990's, the U.S. welfare state became the subject of intense political debate, culminating in 1996 with the passage of the Personal Responsibility and Work Opportunity Reconciliation Act (PRWORA). This was the first major reform of the U.S. welfare system since the 1960's. The main goals of the 1996 reform included reducing the use of public assistance and increasing the employment and earnings of the poor (Blank, 1997). To achieve these goals the 1996 reform

mandated work requirements as a precondition to receive benefits, limited the life-time use of certain benefits, and gave states more discretion over program design. In particular, state entitlements to open-ended federal funds were substituted with block grants, leaving states with autonomy over individual eligibility criteria. The 1996 reform was expected to save about \$23 billion, almost half of which were to come from restricting the access of immigrants to public benefits, in particular Supplemental Security Income. Partly as a result of the 1996 reform, the fiscal impact of immigration has become an important issue at both the federal and local level.

The main issues in the debate on the fiscal impact of immigration are: the relative use of public resources by immigrants, the sensitivity of location choice by immigrants to state welfare benefits (welfare magnet effects), cost sharing between federal and state and local authorities, the overall impact of immigration on public finances (especially social security), and the design of fiscal policy. We consider each issue in turn.

5.1 Use of Public Resources by Immigrants

Though the topic is controversial, most academic studies agree that immigrants have higher welfare participation rates than natives.⁶⁴ The main points of disagreement are on how to measure this ‘excessive’ use of public resources and on its causes. In particular, the methodological issues include the definition of welfare benefits, the reliability of data sources, and how to select the unit of analysis (Fix, Passel, and Zimmerman, 1996).⁶⁵

Immigrant welfare participation has increased in the last thirty years. Before 1980, immigrants had a lower probability of receiving public assistance than U.S. natives (Blau, 1984). In 1970, 5.9% of immigrant households received cash benefits, compared to 6.9% of native households; in 1990, 9.1% of immigrant households received cash benefits, compared to 7.4% of native households (Borjas, 1996). When considering also non-cash benefits, the difference is even

⁶³ The first instance of migration policy selecting immigrants on the basis of education was the 1917 Immigration Act, which introduced a literacy test and a head tax on prospective immigrants.

⁶⁴ For a review of the literature before the 1996 welfare reform see OECD (1996).

⁶⁵ The major methodological difference across empirical studies is the definition of welfare programs. Before 1996, means-tested welfare programs comprised three cash programs (Aid to Families with Dependent Children, Supplemental Security Income, and General Assistance) as well as several non-cash programs (Medicaid, Food Stamps, Special Supplemental Food Program for Women, Infants, and Children, Low Income Energy Assistance, and School Lunch Programs), with the cash programs accounting for about one quarter of all expenditure in means-tested programs. The Current Population Sample (CPS) reports only if an individual uses cash subsidies while the Survey of Income and Program Participation (SIPP) reports all kinds of participation in welfare programs but has less coverage over time. The sample size of CPS is much larger than SIPP, allowing more precise estimates and a larger set of control variables. Borjas and Hilton (1996) and Borjas (1996) use a broader definition of welfare benefits (which includes non-cash benefits) than researchers at the Urban Institute and find that in the early 1990’s 20.7% of immigrant households received means-tested public benefits as opposed to 14.1% of native households.

larger (see Table 5.1).⁶⁶ The reasons behind these differences are still debated but appear to include changes in national origin of immigrants, quicker assimilation of the immigrants to the welfare system, and increases in the number of refugees.

First, the national and education composition of immigration has changed and the new immigrants have demographic characteristics that make them more likely to participate in welfare programs than in previous years. Given that welfare transfers are negatively correlated with income, the simple change in composition of immigrations resulted in an increase in welfare benefits for immigrants. Table 5.2 illustrates the huge differences in use of means-tested programs across households from different countries of origin. For instance in 2000, 54% of the head of households from Dominican Republic used at least one welfare means-tested program while only 2.9% of households from United Kingdom did.

Second, as immigrants have become accustomed to the welfare system the welfare participation of each cohort has increased over time, holding constant observable characteristics (Borjas and Trejo, 1991; Borjas and Hilton, 1996). There is also evidence that ethnic networks play an important role in spreading information on the availability of welfare programs. For instance, Mexican immigrants are 50% more likely to receive energy assistance than Cuban immigrants but the latter are more likely to receive housing subsidies (Borjas, 1999). Confirming this anecdotal evidence, Borjas and Hilton (1996) show that use of welfare services by earlier immigrants of a particular ethnic group is a good predictor of future use of the same services by new immigrants of the same group.

Third, use of welfare benefits by refugees, which was relatively high thirty years ago, has increased further, as the share of refugees in total immigrants has risen from 12% in the 1970's to 17% in the 1980's. Borjas (1995a) finds that the welfare participation rate was 7.8% among non-refugee households in 1990 compared to 7.4% among native households but it was 16.1% among refugee households. Moreover, the use of cash welfare benefits has increased considerably among refugee households from 7.1% in 1970 to 11.6% in 1980, and to 16.1% in 1990.⁶⁷ There appear to be three reasons why refugees use more welfare benefits than other immigrants. First, refugee

⁶⁶ The extent of the public assistance is even larger if we consider the Earned Income Tax Credit (EITC), which is the largest means-tested cash program with a cost of about \$25 billion (Camarota, 2001). Individuals qualifying for EITC pay negative federal taxes, i.e. they receive cash assistance from the federal government. In 2000, 25.5% of immigrant households received the EITC compared with 13.1% of native households.

households are relatively poor, have more problems in being integrated in the labor force, and need more special assistance. Second, refugees are also older than the other immigrants, accounting for 27% of the immigrants over 65 who receive public benefits (Fix, Passel, and Zimmermann, 1996). Third, for humanitarian reasons the U.S. Congress has exempted refugees from the public charge provision of immigration law, making them eligible for benefits upon arrival.

In addition to the aforementioned reasons, the increasing use of welfare by immigrants is due in part to the specific situation of California, which has relatively generous welfare programs and a very large share of poor immigrants. Because of these factors, California has become a national laboratory of many issues regarding immigration, the welfare state, and cost sharing between federal and local governments.

5.2 Welfare Magnets

“...it was enacted by the 43d of Elisabeth, c. 2 that every parish should be bound to provide for its own poor... By this statute the necessity of providing for their own poor was indispensably imposed upon every parish. Who were to be considered as the poor of each parish, became, therefore, a question of some importance. This question, after some variation, was at last determined by the 13th and 14th of Charles II. When it was enacted, that forty days undisturbed residence should gain any person a settlement in any parish... Some frauds, it is said, were committed in consequence of this statute; parish officers sometimes bribing their own poor to go clandestinely to another parish...”
Chapter X. Wealth of Nations. 1776. Adam Smith.

The lines above, which were written more than 200 years ago, highlight many relevant issues of the present debate on immigrants, the perverse effects of the welfare magnets, and the different and sometimes conflicting interests of national and local authorities. The names of the actors have changed but the plot is similar. First, the central authority (the Queen then, the U.S. Congress and federal courts now) gives a mandate to local authorities to care for poor immigrants. Second, some local authorities (parishes then, states now) become welfare magnets and try to restrict the access to welfare benefits for immigrants. Third, central authorities (the King then, the Federal Courts now) mandate criteria for eligibility. As was the case more than 300 years ago, the issue of welfare magnets is crucial in a de-centralized welfare system.

California, which has relatively generous welfare transfers, is host to more than 30% of the U.S. foreign-born population (see Table 2.3). These facts have brought up the question whether poor immigrants choose their location according to the generosity of welfare benefits at the local

⁶⁷ The U.S. census does not contain information on the type of entry visa used by households but provides information on the

level. Borjas (1999c) documents that welfare-recipient immigrants are more likely to cluster than immigrants who do not receive welfare. In the 1980's California was home to 29% of new immigrants who did not receive welfare benefits but 45% of new immigrants who did.⁶⁸

Welfare magnets could have a second undesirable effect by inducing a sub-optimal provision of public goods in reaction to a presumed abuse of welfare benefits. Providing evidence on this point, Brueckner (2000) suggests that benefit levels in nearby states affect a given state's level of benefits. The size of the distortion is unclear given that welfare levels are the result of a strategic interaction among states, the federal government, and voters. Moreover, it is difficult to quantify a benchmark for the optimal level of welfare benefits.

Overall, it seems that there is some evidence on the existence of welfare magnets. As the quotation from Adam Smith suggests, this may be an inevitable feature of a decentralized welfare system, which gives more control at the local level but can induce opportunistic behavior. One important issue is to quantify welfare costs and to weigh them against benefits derived from local control. The U.S. welfare reform of 1996 is still too recent for a full evaluation of its impact.

5.3 Sharing the Costs between Central Government and Local Authorities

Before 1996, the United States had a limited set of federal policies explicitly aimed at immigrants. In practice, legal immigrants had access to the same welfare programs as natives. This situation had been sanctioned by several rulings of federal courts that established that local authorities could not discriminate against legal immigrants in public welfare programs. Moreover, before 1996 the federal government was ultimately funding and regulating the use of welfare programs by immigrants. In addition, some states, such as Massachusetts, have supplemented federal aid with additional programs targeted at immigrants, such as teaching English as a second language (Fix and Tumlin, 1997).

The 1996 Personal Responsibility and Work Opportunity Reconciliation Act and the 1997 Balanced Budget Act changed this situation and affected both eligibility criteria and the funding structure. In the short run, the change of eligibility criteria was the most important innovation; in the long run, however, the change in financing scheme was more relevant as it has moved the immigration debate to the local level. The 1996 Act restricted immigrant access to welfare benefits,

country of origin. For these reason, Borjas (1995a) uses nationality as a proxy for being a refugee.

marking a clear break with the previous policy of equality between legal immigrants and natives. The 1997 Act restored some benefits such as Medicaid to all elderly and disabled immigrants but did not change the principle that natives and legal immigrants have different access to welfare benefits.⁶⁹ There is still concern over the effects of welfare reform on poor immigrant groups, and in particular on children. Moreover, many critics have raised concerns about the cost effectiveness of excluding immigrant children from Medicaid. Currie (2000) observes that curtailing Medicaid eligibility for immigrant children may not save money if children remain eligible for costly emergency care. In addition, even entitled immigrants appear to have received fewer welfare benefits after 1996, perhaps because of uncertainty about their immigration status and eligibility for assistance.

The biggest changes of the 1996-1997 reforms will be for the immigrants arriving after August 1996, who are barred from using Medicaid, Temporary Assistance to Needy Families, and other federal means-tested benefits for the first five years after they enter the United States. After the five-year period, their eligibility will depend on the state in which they reside.⁷⁰ Table 5.3 summarizes the eligibility criteria for non-citizens before and after the recent welfare reforms.

The decentralization of the welfare system will likely be the most important long-run legacy of the 1996 reform. Since 1997, state entitlements to open-ended federal funds for welfare programs were substituted with block grants, which were fixed at the nominal level of the transfers at the beginning of the 1990's. This new legislation makes poor natives and immigrants compete for the same resources at the local level, especially in states with high immigration and relatively generous social benefits. In this respect, the debate has been particularly strong in California because public benefits have been perceived as "too generous" towards immigrants, with the undesired results of attracting the "wrong" immigrants. Moreover, California has committed to providing food stamps to many poor legal immigrants barred from receiving federal assistance. The cost of this commitment has been estimated at around \$60 million annually (Urban Institute, 2001).

Apart from the standard welfare programs, immigrants also use educational services, which may represent the largest implicit transfers to immigrant families. Table 5.4 illustrates the estimated contribution of immigrants to the school-age population. McCarthy and Vernez (1998) document

⁶⁸ This has happened because California attracts a disproportionate number of less-skilled and poor immigrants, who are more likely to receive welfare benefits. This evidence is consistent with the existence of welfare magnets but is also compatible with other explanations such as immigrant network effects.

⁶⁹ The effectiveness of this measure is somewhat limited given that many immigrants have been excluded from the extension. For instance, only 1.4 million non-citizens lost food stamps after 1996 (Fix and Tumlin, 1997).

⁷⁰ Asylees, Refugees, Cubans, Haitians, and other few groups are eligible to means-tested programs for their first five to seven years after entering the United States.

that enrollment in primary and secondary schools in California increased substantially after 1980 thanks largely to immigrant children. In 2000, 43.3% of the school-age population in California had foreign-born mothers. Moreover, given higher fertility rates among immigrants, children of immigrants will represent an increasing share of the school-age population in the future. This fact and a high concentration of refugees largely explain why California transfers more on net to immigrants than do other states.⁷¹ For this reason, it is not surprising that the political debate in California has focused on immigration. Voters in the state have passed anti-immigrant initiatives, such as Proposition 187, which have received much attention at the national level (see box).

Proposition 187 in California

After a heated debate in 1995, Californian voters approved Proposition 187, which denied education, health and social services to illegal immigrants. While Proposition 187 regarded only the provision of public benefits to illegal immigrants in one state, its passage had huge political significance and influenced the reform of federal welfare in 1996.

Even though the public debate focused on education and health issues, fiscal considerations seemed to play an important role in the passage of Proposition 187. Over the past two decades, California has been struggling to contain state public expenditure, given self-imposed taxation limits passed in 1978. Public expenditure in education takes a large share of the state budget (for instance, Proposition 99 earmarks 40% of California's general state public revenues for K to 14 education) and a large proportion of students are children of legal and illegal immigrants. Proposition 187 thus would have likely lowered substantially transfers in the form of public education to immigrants. Passage of the measure may have been helped by the facts that it cut benefits for immigrants who are ineligible to vote and that immigrants in general have historically had lower voter participation rates in local and national elections. One consequence of Proposition 187 appears to have been to increase the political participation of immigrants at local and national levels.

Proposition 187 did not become law because it was successfully challenged by a federal lawsuit on the grounds that it would have unconstitutionally usurped federal authority by enacting immigration laws in conflict with federal authorities, violated due process and equal protection guarantees, and conflicted with the 1982 supreme Court decision in Plyler v. Doe, which affirmed the right of immigrant children to a public education.

Even though Proposition 187 has been rejected in court, the 1996 Personal Responsibility and Work Opportunity Reconciliation Act implicitly implemented many of its provisions with the exception of those regarding primary and secondary education.

⁷¹ Smith and Edmonston (1997) have calculated that the net fiscal deficit for providing services to immigrants was \$1178 per native family in 1996 in California, while it was \$232 per native household in New Jersey.

5.4 Overall Annual Fiscal Impact of Immigration

Though the debate has mainly focused on immigrant use of public programs, a very important economic issue is the overall net fiscal impact of immigrants. Does immigration increase or decrease fiscal costs for native taxpayers?⁷²

In order to address this question the U.S. Congress appointed a Commission on Immigration Reform, which requested the National Academy of Science to examine the overall fiscal impact of immigration. The results are contained in two reports by Smith and Edmonston (1997, 1998). These reports and especially the case studies of New Jersey and California laid down a framework to study the problem. Notwithstanding myriad conceptual and data problems, these studies give a broad idea of the magnitude of transfers between native and immigrants households. In 1996, the net annual fiscal burden of immigration considering all transfers at local and national levels is estimated to be between \$166 and \$226 per native household. The main reasons for transfers from natives to immigrants appear to be differences in family structures and income levels: immigrant families have more dependent children who use publicly funded schools and immigrant households are poor and so receive more transfers and pay fewer taxes.⁷³

One major finding of Smith and Edmonston (1997, 1998) is that there are huge differences in transfers across states. Tables 5.5 and 5.6 summarize their results. In the absence of immigration, the average native household would have taxes reduced by \$1,174 in California and by \$229 in New Jersey. The average immigrant household receives transfers of \$3,463 in California and \$1,484 in New Jersey. The reasons for these cross-state differences are differences in demographic structures and welfare schemes across states. In particular, the foreign-born population in California is younger and poorer, and has more dependent children. It is important to note that the largest transfer between natives and the foreign-born is related to public education.⁷⁴

⁷² The overall economic impact of immigration, which is the sum of fiscal, product, and labor market effects, appears to be small. Borjas (1999) calculates that through its impact on factor markets immigration increases native GDP by about 0.1%. This section discusses results that suggest that the fiscal impact is also negligible. Therefore, the total economic impact of immigration in the United States appears to be limited, at least under the present policies.

⁷³ These studies must address difficult conceptual and data problems. One problem is the classification of public goods, for which by definition there is no additional cost due to immigration. For instance, defense expenditure does not in principle depend on the number of immigrants. This is one reason why the study finds that immigrants are net contributors to the federal government, which is the main provider of public goods. Another problem is to establish who ends up paying for a given tax, which could be a different entity than the one on which the tax is levied. Given the many assumptions required and the complex nature of the issue, most estimates are at best indicative.

⁷⁴ There is evidence that there is also an implicit education subsidy beyond K to 12 education. Data from the General Accounting Office suggest that foreign-born students are more likely to receive grants in Californian universities (see "Distorted Incentives: The United States Pays the University of California Twice as Much to Educate Foreign Graduate Students as American Ones", CIS Backgrounder, February 2000, <http://www.cis.org>).

Apart from these specific estimates, the studies contained in Smith and Edmonston (1997, 1998) highlight the key determinants of immigrants' fiscal contribution and show how the impact differs across states. For instance, the age structure and the ethnic composition of the immigrants have large effects on the fiscal effect of immigration. An average immigrant household in California receives net benefits for \$4,977 if the members are from Latin America, but contributes \$1,308 if the members are from Europe or Canada.

5.5 Long Term Impact of Immigration on Public Finances

While estimating the annual effect of immigration is indicative of its short-run fiscal implications, looking at the dynamic impact is conceptually more appropriate for several reasons. First, an immigrant's net fiscal contributions may vary over his or her life cycle. Being relatively young, immigrants may be net beneficiaries shortly after arriving but net contributors later on. Second, the composition of new immigrants may change over time with important fiscal effects. Third, fiscal policy may also change over time. Given these factors, a simple extrapolation from the annual estimates may be misleading.

Smith and Edmonston (1997) evaluate the long-run net fiscal impact of immigration under different assumptions. Under a baseline scenario, fiscal policy is set so that the debt/GDP ratio is kept constant, newly arriving immigrants have the average characteristics of the current foreign-born population, and the speed of assimilation to natives' wages and family structure is the same as in the past. In this case, Smith and Edmonston (1997) find that the overall present discounted value of the effect of immigration is positive, with significant variations over time. Immigrants' annual net contributions in the first two decades are negative but afterwards become positive. The estimated long-run fiscal impact of 100,000 more immigrants (with average characteristics) per year would be a decrease in taxes by less than 1% (Lee and Miller, 2000). This result *is* influenced by small variations in the aforementioned assumptions.

As with static exercises, one contribution of this study is to highlight the important factors in determining the long-run fiscal effects. Table 5.7 reports the present discounted value of the estimated fiscal contribution of immigrants with different education levels. Again, the most important variables are age and educational level. The net present value of the fiscal impact is at the maximum for an individual with an arrival age between 10 and 25 years, right after most educational expenditure has been incurred, and declines afterwards. More educated immigrants are positive net

contributors, while immigrants with an education of less than high school are negative net contributors. A second important insight of the study is that the mismatch between net federal fiscal gain and net local fiscal loss will increase over time. This is largely due to the fact that the goods provided at federal level are mostly public goods whose cost does not increase with immigration, while many public services used by immigrants, such as education, are funded at the local level.

The study in Smith and Edmonston (1997) has limitations. First, it assumes that future taxes and/or cuts in benefits will stabilize the national debt, while public debt has already been reduced since the late 1990's. Second, it does not consider the observed trend of a decline in the relative earnings ability of immigrants. Third, it does not consider political economy mechanisms, which could change fiscal policy.

Addressing the first two issues, Auerbach and Oreopoulos (1999) argue that the fiscal impact will be more positive (or less negative) if the burden of taxation is shifted to the future when immigrants will be net contributors. Hence, the present reduction of federal budget deficits reduces immigrants' net fiscal contribution. Moreover, Auerbach and Oreopoulos (1999) find that the educational composition of immigration is key and the present trend towards relatively less educated immigrants could decrease net fiscal benefits in the long-run. It is worth reiterating that the evaluation of the overall fiscal impact depends on how broad is the definition of public goods. In sum, these studies indicate that the fiscal impact of immigration is likely to be very small, such that immigrants are neither a solution to fiscal problems nor the cause of sizeable imbalances⁷⁵.

The third issue to be considered is how immigration changes the political economy of fiscal policy. While the aforementioned studies have considered how immigration affects fiscal policy under the present rules (Smith and Edmonston, 1997) or with exogenous changes (Auerbach and Oreopoulos, 1999), endogenous changes to the fiscal stance are relatively unexplored. Spilimbergo (1999) points out that free mobility of workers between a rich (North) and a poor country (South) often leads to fiscal transfers from North to South (e.g. between United States and Puerto Rico, West and East Germany, North and South Italy). This could be rationalized in the context of a political equilibrium in which workers in the North are willing to be taxed and pay a subsidy to avoid excessive migration. In this case, migration (or threat of migration) results in higher taxation.

⁷⁵ After the studies by Smith and Edmonston (1997, 1998) and Auerbach et al. (1999), other studies have confirmed the basic results that immigration has a negligible effect on fiscal position over the long run. For instance, by calibrating an overlapping generation model Storesletten (2000) finds little fiscal impact of current immigration. However, he shows that a selective immigration policy favouring high-skilled working age immigrants has sizeable fiscal benefits.

The previous reasoning presupposes that immigrants are not yet present in the country. If, however, there are relatively poor immigrants already in the country, then the incentives can be turned around. Razin, Sadka, and Swagel (1998) argue and show evidence that low skill immigration may lead to a lower tax burden and less redistribution than would be the case with no immigration. Using a similar argument, Wildasin (1994) shows that migration can lead to a Pareto-inferior outcome in the destination region if immigrants are beneficiaries of redistributive transfers.

5.6 Immigration and Social Security

If the overall long-term fiscal impact immigration is small and ambiguous, its impact on Social Security is easy to determine using the present contribution and benefit rules. Gustman and Steinmeier (2000) argue that immigrants arriving after 1980 receive more benefits than taxes and so are net beneficiaries of the social security system. The reason is that the social security benefit formula transfers benefits toward those with low lifetime covered earnings, and all years an immigrant spends outside the United States are treated as years of zero earnings. Moreover, immigrants with high income who have worked in the United States for only a decade benefit even more, so the present social security system appears to favour relatively rich foreign-born individuals.

Though the previous study carefully computes the effects of immigration within the present rules, it does not account for dramatic increase in “illegal contributions” to social security. Since the Immigration Reform and Control Act (IRCA) was passed in 1986, employers have required social security cards from their employees. Many illegal aliens have met this requirement by obtaining fake social security cards, which can be purchased in many cities for as little as a few hundred U.S. dollars. The contributions made using these fake Social Security numbers, which cannot be matched to names legally recorded in the Social Security System, are collected in a ‘suspense file’ with other contributions to the Social Security System that will not generate corresponding benefits. A relatively small amount of money in this ‘suspense file’ is normal given that people make mistakes in assigning their contributions. However, the increase in funds in this category has been dramatic in the years following the passage of IRCA. The taxes collected from suspended W2 forms rose from \$1.2 billion in 1990 to nearly \$4 billion in 1998. During the 1990-1998 period, these contributions amounted to more than \$20 billion (Sheridan, 2001).⁷⁶ Consistent with the idea that

⁷⁶ The IRS and Social Security System are bound by law to keep personal information confidential and so do not share this information with other governmental agencies such as the Immigration and Naturalization Services. Another way in which “illegal taxpayers” contribute to fiscal accounts is through automatic deduction from wages. Relatively poor and illegal

illegal immigrant are responsible for this surge, most of these contributions come from areas and industries that typically employ many illegal workers, such as agriculture, restaurants and bars, etc.

5.7 Summary

The net fiscal impact of immigration appears to be small at the aggregate level in the long-run. The key variables in determining the size and the sign of the net fiscal contribution are the age and education level of immigrants at time of entry in the United States. Present policies, which allow for admissions of refugees and family reunification, may heighten (directly and indirectly) the fiscal cost of immigration.

Even if the aggregate fiscal impact is negligible, the fiscal costs and benefits of immigration are not distributed equally between local and federal governments or across time. In general, the federal government is a net gainer, while many states lose because redistributive programs are often locally funded and because the federal government provides more public goods whose cost does not rise with immigration. Moreover, the burden is distributed unequally across states because relatively poor immigrants cluster in a few gateway states. The welfare reform in 1996, which has devolved the administration and financing of many welfare programs to the states, appears likely to worsen this financing mismatch. In the short run, immigrants appear to make a negative net contribution to fiscal accounts because they are relatively young and poor. In the long-run, however, immigrants are estimated to make a positive net contribution to fiscal accounts.

We should stress the uncertainty of the assumptions under which these conclusions are drawn. In the short run, we do not know very well how the 1996 welfare reform will affect fiscal accounts during a recession. In the long run, there is uncertainty about demographic and economic variables. Even a small variation in the average education and age at entry could change significantly the fiscal impact. It is also difficult to predict the speed of convergence between immigrant and native wages. In addition, past experience suggests that immigration policies react quickly to changes in the economic environment (Hanson and Spilimbergo, 2001) so that we expect that corrective measures will be taken promptly if the fiscal impact becomes large, especially in specific states.

immigrants who pay taxes through automatic deduction cannot claim a rebate at the end of the year because their Taxpayer Identification Number is illegal. Finally, it seems that many illegal immigrants who are paid in cash pay taxes in order to build a record to prove their presence in the country in case of a future amnesty (Sheridan, 2001).

6. The Political Economy of Immigration Policy

As the previous sections have made clear, immigration has important—if contested—effects on the U.S. economy and so on this basis alone is an important political issue. Immigration is also, however, about deciding membership in a political community and, as such, is one of the most fundamental and controversial political choices facing national policymakers. Given the critical economic and political issues at stake, what are the factors that have shaped U.S. immigration policy over recent decades?

Like all areas of policymaking in democracies, U.S. immigration policy is determined by the preferences of voters, firms, and interest groups and how the political system aggregates these preferences. The aggregation of preferences is particularly sensitive to how successful different groups are in solving their respective collective action problems and organizing themselves effectively to influence policy decisions. U.S. political institutions also influence the costs and benefits of various political actions and thus advantage some groups over others in the policymaking process. In this section, we identify the preferences of the main actors in the U.S. immigration debate and how successful those actors are in getting their views implemented into policy. We focus on explaining the patterns of political conflict about immigration rather than accounting for why particular pieces of legislation have succeeded or failed in becoming law over recent decades. This approach allows us to learn as much as possible about the systematic factors that are likely to influence future U.S. policy choices about immigration and avoids excessive attention on the idiosyncratic events that have determined the fate of various legislative proposals.

Our analysis shows that political conflict over immigration policy has a number of important dimensions. From the opinions of individual citizens about policy to votes on legislation by members of Congress, it is clear that the politics of immigration policymaking is influenced by the perceived economic consequences of policy alternatives and, in particular, on the distribution of these economic effects. The evidence also demonstrates, however, that other considerations such as beliefs about the impact of immigration on the welfare state play an important role in the course of policymaking. In addition to this description of the sources of political conflict about immigration, we also argue that the common characterization of immigration policymaking in the U.S. as a process dominated by organized interests and uninfluenced by diffuse interests in the electorate is incorrect. While it is clear that organized

interests play an important role in the making of immigration policy, there are substantial theoretical reasons why diffuse interests may also get represented, and we present empirical evidence consistent with this argument.

The remainder of this section examines the preferences of the American public and other important groups involved in the immigration debate and how those preferences are aggregated in the making of national immigration policy.

6.1 Preferences

Our analysis begins with the identification of the preferences of U.S. citizens and employers about immigration policy. For individuals, our approach is to use survey data to determine what, if anything, U.S. citizens think about immigration policy and why they hold the opinions that they do. Our discussion will highlight the key patterns of public opinion in the U.S. based on our review of a large dataset of survey results over the last several decades⁷⁷.

The most striking characteristic of U.S. public opinion about immigration is that a consistent plurality to majority of Americans prefers more restrictive immigration policies. For example, the following questions suggest that more Americans prefer decreasing the number of immigrants than to the status quo and that fewer than 10% of respondents favor increasing the number of immigrants.

Question: “Do you think the number of immigrants from foreign countries who are permitted to come to the United States to live should be increased a little, increased a lot, decreased a little, decreased a lot, or left the same as it is now?”

Answers, 1996:

Increased a lot:	1.6%
Increased a little:	3.1%
Left the same:	32.9%
Decreased a little:	26.5%
Decreased a lot:	24.5%
Don't Know/No Answer:	11.5%

Answers, 1994:

Increased a lot:	1.7%
Increased a little:	3.5%
Left the same:	28.2%
Decreased a little:	21.9%
Decreased a lot:	41.0%
Don't Know/No Answer:	3.7%

Answers, 1992:

Increased a lot:	2.6%
Increased a little:	5.1%

⁷⁷ This review builds on previous research on public opinion in the U.S. about immigration policy. See, for example, Citrin, Green, Muste, and Wong (1997); Espenshade and Hempstead (1996); Fetzer (2000); Gimpel and Edwards (1999); Scheve and Slaughter (2001a, 2001b); and Simon and Alexander (1993).

Left the same: 41.6%
Decreased a little: 24.5%
Decreased a lot: 22.4%
Don't Know/No Answer: 3.9%

(Source: National Election Studies Survey, 1992, 1994, 1996)

Underlying these restrictive policy preferences is recognition by the majority of Americans that immigration has some clear economic and cultural benefits. When asked a simple question about whether immigrants bring benefits to the country, nearly 70% of respondents agree that they do.⁷⁸

Question: “Do immigrants help improve our country with their different cultures and talents?”

Answers: Yes: 69%
No: 28%
Don't Know: 3%

(Source: Gallup/*Newsweek*, August 1990)

On the other hand, the surveys suggest that Americans are clearly concerned about the possible labor market costs of immigration. In particular there is a perception that immigrants may take jobs from American natives. The following question asks respondents whether immigrants “take jobs away” from people already in the United States and indicates that the large majority thinks immigrants do take jobs—with a plurality responding this outcome is either extremely or very likely.

Question: “The growing number of Hispanic immigrants [in the U.S. economy]: How likely is it to take jobs away from people already here?”

Answers: Extremely likely: 17.7%
Very likely: 25.6%
Somewhat likely: 33.2%
Not at all likely: 11.9%
Don't Know/No Answer: 11.6%

(Source: National Election Studies Survey, 1992)

Question: “The growing number of Asian immigrants [in the U.S. economy]: How likely is it to take jobs away from people already here?”

Answers: Extremely likely: 16.7%

⁷⁸ Although this question is asked at a very general level, other surveys indicate that the U.S. public attributes to immigrants many of the benefits we would expect. For example, when asked in 1986 “What do you think is the most important thing immigrants have done for this country?”, the most frequent answers include “built U.S.,” “variety of cultures”, and “work hard/help the economy” (Source: CBS News, New York Times). Moreover, the view that immigrants work hard and contribute to economic productivity is not confined to immigrants of previous eras. In the same survey, respondents were asked “Generally, do today's immigrants work harder than people born here, not as hard, or isn't there much difference?” A full 45% of respondents chose the “harder” response with only 8% indicating “not as hard” (Source: CBS News, New York Times).

Very likely: 26.8%
Somewhat likely: 32.8%
Not at all likely: 11.9%
Don't Know/No Answer: 11.8%

(Source: National Election Studies Survey, 1992)

It is worth pointing out that these questions do not specify whether the respondent is expected to consider the short-run or long-run effects of immigration. As indicated in section 3's discussion of the labor market effects of immigration, economists do not generally consider immigration to alter national unemployment rates—particularly in economies with flexible labor markets. Nevertheless, the answers to this question indicate that individuals are sensitive to the effects of immigration on labor market competition generally and think about competition in terms of jobs. Below, we will consider whether the effects of immigration on the labor market outcomes that economists emphasize—specifically wage pressures—help to explain cleavages in public opinion about immigration.

Another consideration that seems to underlie public concern about immigration is its impact on the welfare state. The economic effects of immigration are not limited to its impact on outcomes in the labor market or its possible small but positive effects on economic growth. Immigration clearly affects the welfare state as well. A key concern of the American public is whether or not immigrants pay their way. In the following questions, nearly 55% of respondents think that it is extremely or very likely that the growing number of Hispanic immigrants will cause higher taxes due to increased demand for public services. When the reference group is Asian immigrants, a lower but still substantial 38% give the “extremely” or “very likely” response.

Question: “The growing number of Hispanic immigrants [in the U.S. economy]:
How likely is it to cause higher taxes due to more demands for public services?”

Answers: Extremely likely: 18.8%
Very likely: 36.1%
Somewhat likely: 34.5%
Not at all likely: 7.1%
Don't Know/No Answer: 3.4%
(Source: National Election Studies Survey, 1992)

Question: “The growing number of Asian immigrants [in the U.S. economy]:
How likely is it to cause higher taxes due to more demands for public services?”

Answers: Extremely likely: 11.1%
Very likely: 26.6%
Somewhat likely: 41.6%
Not at all likely: 16.9%

Don't Know/No Answer: 3.8%
(Source: National Election Studies Survey, 1992)

It is clear from these questions as well as other survey evidence that concerns about the fiscal effects of immigration contribute substantially to public skepticism about liberal immigration policies.⁷⁹

Our discussion thus far has focused on how the U.S. public assesses the aggregate economic costs and benefits of immigration and how on balance it prefers generally more restrictive policies compared to the status quo. It remains unclear from this description, however, whether there are important cleavages in public opinion about immigration. As discussed in the previous sections, the evidence seems to indicate that some of the biggest effects of immigration on the U.S. economy are distributive. For example, under current immigration laws, there are theoretical reasons—albeit supported by mixed empirical evidence—to think that the flow of relatively less-skilled workers into the U.S. harms the labor market outcomes of similarly skilled native workers while more-skilled natives are left better off. To the extent that different immigration policy alternatives have clear distributive consequences, this is likely to generate conflict in the policy debate with winners and losers from liberalization advocating policies consistent with their interests. The importance of distributive issues is likely to be particularly significant in a policy area like immigration for which the net balance of the aggregate costs and benefits to the U.S. economy seems to be small (and the direction contested).

If the distributive consequences of immigration influence individual policy preferences, then public opinion about policy will be characterized by distinct economic cleavages. The key question is whether the types of individuals who are most likely to be hurt economically from current immigration are most supportive of further restrictions. Evaluating this question requires assessing the determinants of individual opinions about immigration. Why do some individuals support more-restrictionist policies while others are opposed? Individual opinions surely depend on a host of considerations, including political ideology, ethnic and racial identity, expectations about the economic impact on the nation as a whole as well as on how policy alternatives affect individuals' own personal economic welfare. Among distributive concerns, the anticipated effect

⁷⁹ When asked to make an overall economic assessment of the costs and benefits, a majority appear to believe that the costs outweigh the benefits. In 1985, Americans were asked "Generally speaking, do you think that refugee immigrants to the United States take more from the U.S. economy through social services and unemployment than they contribute to the U.S. economy through taxes and productivity--or haven't you heard enough about that yet to say?" Respondents chose the "take more" response 46% of the time and the "contribute more" response 19% of the time.

of immigration on wages is likely to play a key role, as labor income is a major determinant of individual economic welfare. Because labor income depends primarily on individual skill levels, there may be a significant link from skills to wages to immigration-policy preferences. Our distributive question then becomes, do individuals with different labor market skills have different preferences about immigration policy? Recall from section 3 that different economic models make contrasting predictions about the nature of the link from immigration to labor income. Here we consider the simple prediction that because immigration under current U.S. law increases the pool of less-skilled workers, immigration increases relative wage inequality and, under the assumption of fixed product prices, lowers the real wages of less-skilled workers. This relationship is consistent with both the Heckscher-Ohlin and factor-proportions models reviewed in section 3.⁸⁰ To the extent that individuals expect such a relationship between immigration, skills, and wages, we anticipate a link between the skills of workers and the policy preferences that they hold with increasing skills being associated with less restrictive immigration opinions.⁸¹

We examined individual responses to the following question asked in the 1992, 1994, and 1996 National Election Studies (NES) surveys: “Do you think the number of immigrants from foreign countries who are permitted to come to the United States to live should be increased a little, increased a lot, decreased a little, decreased a lot, or left the same as it is now?” We estimated how skill levels, measured by years of education and average wages for an individual’s occupation, and other individual characteristics affected the probability of supporting immigration restrictions (see Appendix for a more detailed description of our methodology). We found clear evidence that individuals with greater skill levels were significantly less likely to support further immigration restrictions controlling for a wide number of other characteristics such as age, gender, race, ethnicity, and political ideology.⁸² Table 6.1 reports the key results assessing the impact of increasing our two skill measures from typical low values—one standard deviation below their sample means—to typical high values—one standard deviation above their sample means—on the probability of supporting further immigration restrictions. For the skill measure *Education Years*, increasing the variable by two standard deviations (from a typically

⁸⁰ Recall though that section 3 emphasized that economies can adjust to immigration through changes in industrial specialization, migration of labor and/or capital, and changes in underlying production technology in addition to changes in wages.

⁸¹ Note that this relationship may be based on past experience for which the empirical literature finds evidence of a small but generally non-zero negative effect of immigration on the wages of less-skilled native workers. Alternatively, it may be based on forward-looking considerations. Section 3 discusses reasons why the conditions that have mitigated the wage adjustment mechanism may not persist in the future.

low level of about 11 years of education to a high level of about 16 years) reduces the probability of supporting immigration restrictions by 10% to 14% over the three survey years. What this means is that if you could put a respondent who was a high school dropout but with otherwise average characteristics through both high school and college, then the probability that this hypothetical individual supports immigration restrictions would fall by about 12%. This correlation between skills and immigration preferences indicates a substantively important cleavage in public opinion about this policy area consistent with its expected distributional consequences in the national labor market.

This analysis establishing a correlation between skill levels and immigration policy preferences pools all regions in the United States. An obvious question raised by the finding is whether the concentration of immigrants in some regions of the country affects policy opinions. The area analysis model discussed in section 3 predicts that wage pressures on less-skilled workers should be strongest in the gateway communities where immigrants are concentrated. This suggests that the link between skill levels and preferences may be stronger among workers in these areas. We tested this prediction using the survey data from the NES along with information about the concentration of immigrants in the region in which the respondent was located. Our analysis suggests that the correlation between skill levels and immigration policy preferences is not higher among people in high-immigration areas than among people elsewhere.⁸³ The differences between less and more-skilled workers in opinions about immigration policy are similar throughout the country.⁸⁴ Moreover, we find no evidence that, controlling for individual characteristics, opinions are generally more or less restrictionist in regions with higher concentrations of immigrants.

The skill cleavage that we do observe raises a number of questions regarding public opinion about immigration policy. Note that the question that we analyze does not ask what skill mix immigrants would have relative to natives. We assume that respondents think that immigrant inflows would increase the relative supply of less-skilled workers. This assumption is reasonable as it clearly reflects the facts about U.S. immigration in recent decades. However, the options that policymakers face include changing not only levels of immigration but also the

⁸² The correlation between skills and immigration policy preferences is robust to changing or eliminating the conditioning information. Details about the data, estimation procedures, and results are available in Scheve and Slaughter (2001a, 2001b).

⁸³ See Scheve and Slaughter (2001a, 2001b) for details about the estimation procedures and results on this point.

characteristics of those entrants. Although there is clear evidence of a skill cleavage in current public opinion about immigration, this should be understood in the context of current U.S. policy and immigration experience. It is perfectly possible for this cleavage to disappear or even reverse itself if the skill mix of immigrants was altered. In fact, theoretically we would expect such a change.

It is, of course, difficult to assess what preferences would look like in a different policy regime in which immigrants were relatively more skilled. Nevertheless, although we do not have much evidence on what would happen to the skill correlation, indirect evidence suggests that restrictive opinions about immigration policy might be significantly reduced as the skills of immigrants increase. The first piece of evidence on this point takes advantage of the fact that different communities have different skill mixes of immigrants. Do individuals have more or less restrictive policy preferences in geographic regions with more-skilled immigrants? To answer this question, we obtained data on the educational attainment of the immigrant population in the local communities represented in the NES surveys discussed above. We found evidence that individuals living in communities with more-skilled immigrants were somewhat less likely to support further immigration restrictions. This finding is only suggestive as the immigration question queries respondents about national policy and it is not clear how heavily individuals weigh local immigrants in evaluating policy. Moreover, it is important to recognize that increasing the skill level of immigrants is just as likely to affect individuals' assessment of the fiscal effects of immigration as it is to impact their evaluation of its consequences for the labor market. Respondents may have less restrictive opinions in areas with more-skilled immigrants because they expect skilled entrants to contribute more in taxes than they take away in government services and transfers.⁸⁵

The second piece of indirect evidence on how the skills of immigrants might affect public preferences about immigration policy is that opinion varies substantially with the geographic origin of immigrants. Although immigrants from different parts of the world may differ in many

⁸⁴ The finding of a skill correlation that does not vary across regions according to the concentration of immigrants is consistent with the factor-proportions and Heckscher-Ohlin models that assume a single national labor market but is inconsistent with the area-analysis model.

⁸⁵ Note that in 1984, Americans were asked "Let's imagine that you were a U.S. government official and that your job was to make decisions about who should and should not be admitted into this country. For each of the persons I describe, please tell me if you think that person should or should not be admitted into the U.S...". 64% responded that a person "with job skills very much in demand in the U.S." should be admitted. This question does not explicitly state that the skills in demand are high skills but it is clear from the question that the hypothetical immigrant will likely pay their way.

characteristics, one difference that is well documented is their skill levels (Borjas 1994, 1999a).

Consider the following question posed to the U.S. public in 1965.

Question: “Here is a list of countries and parts of the world. If we are going to allow more people into this country as immigrants, which places on this list would you most prefer they come from...Canada, England or Scotland, Scandinavia, Germany, Ireland, France, Italy, Poland, Mexico, Latin America, Eastern Europe, Middle East, Asia, or Russia?”

Selected Answers:

Canada:	28%
England or Scotland:	28%
Germany:	17%
Italy:	7%
Mexico:	5%

(Source: Harris, 1965)

Similarly, more recent surveys have asked whether the U.S. accepts too many, too few, or about the right number of immigrants from various parts of the world. The proportion responding “too many” ranges from over 50% for “Latin America” to about 30% for “Europe”.⁸⁶ There are obvious limitations to each of these types of questions.⁸⁷ Nevertheless, the evidence suggests that the U.S. public is more receptive to immigration from countries whose immigrants have been relatively more skilled. Consider the five countries for which answers are reported in the Harris question above. The average years of education of immigrant men in the U.S. for 1990 are 13.8 for Canada, 14.6 for the United Kingdom, 13.9 for Germany, 10.9 for Italy, and 7.6 for Mexico Borjas (1994).⁸⁸

The evidence that we have reviewed so far has focused on the economic considerations that determine the overall direction of U.S. public opinion about immigration policy and the variation in opinions among different types of individuals. Immigration policy, however, is also a political decision and, as such, preferences are likely to be influenced by considerations beyond its labor market effects. For example, opinion may be influenced by preferences about the

⁸⁶ See, for example, 1990 Gallup/Newsweek results.

⁸⁷ The wording for the question asking respondents “Are the numbers of immigrants now entering the United States from each of the following areas too many, too few or about the right amount?” is particularly problematic as the differences in percentages may just reflect that more immigrants arrive from some regions than others, and so an individual wanting less immigrants overall would be more likely to focus on the regions sending the most immigrants. Consequently, differences in responses across regions may or may not reflect the differences in the skill of immigrants in these regions. Nonetheless, the pattern is not inconsistent with the argument that the skills of immigrants matter for patterns of public preferences about policy.

⁸⁸ As discussed above, the increasing support for immigrants by skill level may also indicate assessments about the fiscal effects of immigration. For example, section 5 notes evidence that immigrants from Canada make a positive contribution to fiscal balances while immigrants from Latin America do not. Moreover, the countries that have high-skilled immigrants tend to be European so these survey results raise the further question of the role of attitudes about race and culture on immigration policy opinions, a question we address below. The point made here is simply that differences in attitudes about immigration by country of origin are not inconsistent with the skills of immigrants being a key determinant of public opinion about policy.

welfare state and beliefs about how immigration affects the welfare state. Alternatively opinion may be affected by beliefs about whether immigration affects American culture and whether any perceived changes are desirable or not. One strategy for determining whether these types of considerations influence public opinion is to again look for cleavages in policy opinions about immigration. Do identifiable demographic groups have systematically different policy views? Do individuals with certain political ideologies or attitudes tend to think differently about immigration policy?

We examined these questions in our evaluation of responses to the 1992, 1994, and 1996 NES survey question discussed above. We found there to be systematic differences in the opinions of African Americans and in the views of immigrants and their children. For example, we estimate that African Americans were nearly 10% less likely to support further restrictions on immigration policy than the rest of the population, controlling for other determinants of opinion like skill levels. We found about the same difference to exist for the category of immigrants and children of immigrants. Importantly, political ideology also plays a role in opinion formation. Our analysis suggests that individuals who identify themselves as very conservative are about 10% more likely to support immigration restrictions than individuals who place themselves in the middle of a liberal-conservative ideological scale. The interpretation of this correlation is hardly unambiguous because liberalism and conservatism mean different things to different voters. Nonetheless, it is likely that this correlation is related to preferences about the size of government and, more specifically, the size of the welfare state. Individuals who identify themselves as political conservatives are, all else equal, more likely to prefer small government. Given the trends in use of the welfare state by immigrants reported in section 5, conservatives may object to immigration in part because of the demands it puts on public services and the tax and transfer system.⁸⁹

In addition to these ideological and demographic cleavages, individual immigration opinions may vary due to different levels of tolerance. The political conflict surrounding

⁸⁹ The interpretation of the ideology/immigration policy preferences correlation requires some caution. In one view, individuals have political ideologies that affect and guide their opinions about all sorts of political issues. In this sense, ideology causes immigration opinions. An alternative perspective is that individuals develop policy opinions consistent with their interests and values and ideology is largely a summary statistic for individuals' collective set of policy opinions. In this sense, ideology is a consequence rather than a cause of policy opinions. Even if ideology is to some extent exogenous and a meaningful explanatory variable, it should be interpreted cautiously as although different preferences about the size of government is a salient feature of liberal/conservative political debate in the U.S. so are other issues that may be related to immigration policy. It is worth noting that to the extent that there are ideological differences in opinion about immigration due to its impact on the welfare state, this

immigration often seems to be closely intertwined with more general civil rights debates in U.S. politics. Moreover, the public opinion literature has shown that general attitudes toward racial, ethnic, and religious groups can affect opinions about a wide array of public policies. We investigated this possibility by examining the extent to which immigration policy opinions were correlated with general measures of tolerance. We measured tolerance by respondents' answers to three different tolerance statements or questions (e.g., "We should be more tolerant of people who choose to live according to their own moral standards, even if they are very different from our own"). We found a robust correlation between the tolerance measures and immigration opinions with those with more tolerant attitudes having less restrictionist policy opinions. Further, this relationship held even after controlling for the skill measures, demographic identifiers, and political ideology variables discussed above.⁹⁰

Although it is surely the case that both economic and non-economic considerations influence public opinion about immigration, determining the relative weight of these factors is a much more difficult, if not impossible, task. For example, how to identify the relative role of labor market competition and individual tolerance in explaining opinions about immigration policy is not clear. Intolerance is, of course, in part a symptom and consequence of economic competition. Thus, inferring the relative role of intolerant attitudes and economic threat requires a theoretical model for the relationship between the two that is much more precise than we have available. Adding to the challenge is that tolerance is actually a very difficult attitude to study through the use of public opinion surveys for a number of reasons including it is one of the areas for which it is most difficult to elicit truthful responses. Our view is that while it is clear that both economic and non-economic factors influence public opinion about immigration, the importance of economic factors has generally not been weighed as heavily as it should.

In addition to individual citizens, another large and diverse group that plays a critical role in immigration policymaking is U.S. employers. Firms in a wide variety of industries have expressed preferences for significant changes in U.S. immigration policy. As discussed in section 4, employers requiring relatively less-skilled and often seasonal workers in industries such as agriculture and apparel manufacturing have been among the principal advocates of policy

source of opinion does not fit into a simple economic/non-economic dichotomy. Debate about the size of government reflects distributive conflict as well as differences in tastes.

⁹⁰ It is important to note that the skill-preferences correlation is robust to controlling for these other factors including tolerance. Critically, this indicates that skill measures are not simply proxies for tolerance. See Scheve and Slaughter (2001a, 2001b) for

liberalization. More recently, firms employing highly skilled workers such as software programmers have joined the chorus for immigration liberalization. Employers have not only lobbied for higher immigration quotas within the existing policy regime but also have advocated sweeping changes in immigration law. Many firms, particularly in the context of the tight labor markets of the 1990's, have urged that admission based on family membership criteria be substantially curtailed in favor of skill-based and other criteria that reflect the needs of employers and arguably the national economy. Skill-based immigration policies are especially favored among high-technology companies but in principal may be designed to garner the support of employers of workers with varying skill levels. Thus, the immigration policy opinions of U.S. employers generally favor increasing levels of immigration and other reforms designed to make the levels of immigration allowed as beneficial as possible to their respective industries.

There are, however, important differences among employers in emphasis and in the intensity of preferences. For example, the reintroduction of large-scale temporary immigration favored by many agricultural employers would not meet the needs of many other types of firms. Also, some industries do not employ many workers with the skills of the immigrants admitted under current laws and have not experienced acute shortages for the workers that they do employ. Many of the firms in these industries have fairly indifferent preferences about changes in immigration policy.

6.2 Aggregating Preferences in the Political Process

The previous discussion has suggested that there is substantial variation among and between citizens and firms in immigration policy preferences. Given this variation, how does the political system aggregate these preferences and ultimately set U.S. immigration policy?

To start, consider the breadth of variation in preferred policies. Firms, particularly those employing relatively less and more-skilled workers, have a strong interest in policy liberalization. Among individual citizens, policy opinions seem to be clearly related to the perceived effects of immigration on labor market outcomes. This link is most evident in the differences in preferences between more and less-skilled workers. Less-skilled workers who have the most to lose from immigration under current laws and patterns of immigration are more likely to favor restrictive policies. The public opinion evidence suggests, however, that there are other groups in

more discussion on this point. The ideology correlation is also robust to including the tolerance measures which suggests that

society that seem to have systematically different preferences about immigration that are not necessarily related to its labor market effects. For example, the surveys suggest that beliefs about the impact of immigration on the welfare state may distinguish different groups of voters. The public is generally concerned about whether immigrants burden public services and the tax and transfer system, but political conservatives are especially sensitive to this issue. There is also variation among demographic groups with, for example, blacks, immigrants, and children of immigrants being more likely to oppose further immigration restrictions. Each of these groups regardless of the source of its policy preferences represents a potential interest group that either directly or in coalition with others seeks to influence U.S. immigration policies.

We, of course, do not actually observe active interest groups for every category of individuals or firms that has a clear preference about the direction of U.S. immigration policy. The formation of an interest group with the resources to influence policy requires that those like-minded individuals and firms solve their respective collective action problems. The challenge is simply that individuals or firms that may be better off if they all contribute to a common effort such as lobbying for their preferred immigration policy may not have an incentive to do so because their own contribution is not decisive in the success of the common effort. Consequently, many potential groups with similar preferences are never organized into active interest groups engaged in the policymaking process. The literature on collective action problems generally and interest groups in particular suggests that small groups for which the benefits of organization are concentrated and for which the costs of monitoring each member's efforts are low will be more successful in lobbying for their preferred policies than large groups with diffuse interests.⁹¹ This literature also suggests that many groups will rely on selective benefits not necessarily directly related to the collective good to create incentives for participation. The provision of the collective good is then in some sense a by product rather than the main output of the interest group. The recognition that not all interests are equally likely to solve their collective action problems is important for understanding immigration policymaking. Most studies of the determinants of U.S. immigration policy contend that interest groups dominate the policymaking process and that the interest groups that are successfully organized to

ideology is not simply a proxy for tolerance.

⁹¹ See, for example, Alt and Gilligan (1994); Gilligan (1997); Grier, Munger, and Roberts (1994); Milner (1988); Olson (1965); and Schattschneider (1935).

exert influence reflect the preferences of only some of the relevant groups in society.⁹² In particular, this research suggests that diffuse interests like the ordinary citizens polled in the public opinion surveys presented above are unorganized and largely unrepresented in the policy process.

To understand the asymmetries in organization for immigration policy lobbying, it is instructive to consider what types of interest groups have been active in the U.S. immigration debate. There are, of course, lots of different interest groups that have taken explicit positions on immigration policy. However, three categories of groups are widely recognized to have been important forces in influencing policy debates. Employers of immigrants are the most obvious and their success in organizing the least surprising. These firms are typically organized in industry groups. Within each industry, the number of firms is small compared to the number of individuals in most of the other groups with clear preferences about immigration policy, and the firms have substantial economic interests at stake in changes in immigration policy. Moreover, they often have common interests in a variety of policy areas such as trade and regulation in addition to immigration. Once organized, they can lobby across a number of policy areas. Immigrant groups have also been successful in organizing. These groups face a more difficult collective action problem. Although, as noted above, immigrants are more likely to support liberal immigration policies, they are a large, diverse group for which the benefits of liberalization for any single individual are small. The success of immigrant groups in organizing seems to be due to the fact that many of these groups are organized for entirely different purposes—often for social and/or professional reasons—and then develop a capacity for lobbying. In this sense, their organization for purposes of lobbying for particular immigration policies is a by product of other activities. The same can be said of African-American and other civil rights groups that have been successful in organizing lobbying efforts about immigration policy. These groups are organized for completely different purposes but nonetheless have played an important role in the national policy debate about immigration.

This list is not exhaustive but it is indicative of the general point that the interest groups lobbying about immigration policy are likely to represent concentrated interests or to represent the views of groups organized for reasons other than influencing national immigration policy. Moreover, it is not at all evident that the concerns of the electorate observed in the public opinion

⁹² See Gimpel and Edwards (1999).

surveys are represented by well-organized and well-funded interest groups.⁹³ This leads then to a standard interest group explanation for why U.S. immigration policy has remained relatively liberal in the face of generally restrictive preferences among the American public. The argument is simply that a coalition of employers, immigrant groups, and civil rights groups have lobbied effectively to prevent a significant restrictionist turn in policy. Put differently, the concerns of diffuse groups such as less-skilled workers and fiscal conservatives are not effectively organized on this issue and immigration has not become salient enough in electoral politics to seriously constrain national policymakers.

This account of immigration policymaking is no doubt accurate in its main insight that there is asymmetry in the organization of interests reflecting alternative policy views. To this insight, however, must be added consideration of the strategic situation that faces national policymakers—particularly members of the House of Representatives in the U.S. Congress—and how it may affect the representation of diffuse interests. A number of congressional scholars (Arnold 1990, Bailey 2001, Denzau and Munger 1986, Kingdon 1973) have argued that representatives are sensitive to the concerns of even uninformed voters because they anticipate efforts to mobilize these groups. So although taxpayers and low-skilled workers may not be particularly well-organized compared to other groups with distinct preferences in the immigration debate, members of Congress are likely consider their preferences when making policy decisions in order to insure themselves against mobilization of these groups by political opponents. The argument is simply that the electoral concerns of members of Congress are such that diffuse, unorganized interests may be represented in the policy process even if we observe limited interest group activity.⁹⁴ This insight does not imply that interest group formation and activity is not important for understanding patterns of support for alternative immigration policies but rather that these influences will be checked by the electoral calculations of policymakers.⁹⁵

So given the expected role of organized interests and the electoral constraints faced by politicians, what are the key determinants of the policymaking behavior of members of Congress? In the discussion of immigration policy preferences, we observed differences among individuals in opinions about immigration based on skill type, political ideology, immigration

⁹³ See Gimpel and Edwards (1999) and Kessler (1999) for a detailed description of interest groups active in immigration lobbying.

⁹⁴ See Bailey (1999, 2001) for a full development of this idea within a formal probabilistic voting model with applications to trade policy. He argues that skilled workers are a diffuse group that favors free-trade and finds that members of Congress from districts with relatively more skilled workers are more likely to cast votes consistent with free trade positions.

status, and ethnicity and noted the generally more favorable view toward immigration of U.S. employers. We expect the relative strength of these groups in each member's congressional district to account for variation in voting behavior in the House of Representatives. This includes both those groups that have been widely recognized as well organized and influential in the immigration debate such as employers, immigrants, and civil rights groups and relatively more diffuse groups such as less-skilled workers and fiscal-conservatives. Although a comprehensive analysis of congressional voting on immigration is beyond the scope of this review, we examine a number of key votes in the 1990s to illustrate how these factors can explain political conflict among national policymakers over immigration policy.⁹⁶

The objective of this analysis is to explain votes on immigration legislation in the House of Representatives. Although a given position on each vote can be characterized as more or less restrictive, the interests and preferences of various groups in society (and in each representative's district) depend critically on exactly what aspect of immigration policy is under consideration and what its expected consequences are. To start with, we analyze votes on the Chrysler amendment during key immigration debates during the 104th Congress. This amendment proposed that immigration reform legislation separate issues that were primarily associated with restriction and reform of legal immigration from those associated with restriction and reform of illegal immigration. It was arguably the critical vote determining whether new restrictions on legal immigration would be made, with passage of the amendment damaging any prospects for new restrictions.⁹⁷ Consequently, a yes was a vote in favor of relatively liberal immigration policy under the current policy regime dominated by family-based immigration. Given this content, the following factors are hypothesized to account for variation in Congressional voting behavior:

- *Immigrant Population.* Representatives in districts with greater immigration population are more likely to support relatively liberal policy, particularly for family-based immigration.⁹⁸

⁹⁵ Note that it is not necessary that we observe individual citizens actually voting on the basis of the immigration issue for this constraint to hold. It is as much the threat of the mobilization of interests as actual voting behavior that induces the constraint.

⁹⁶ Explaining variation in congressional behavior provides relatively more insight about the political conflict associated with immigration policymaking than a guide to actual changes in policy. Major immigration legislation is rare and notoriously difficult to anticipate.

⁹⁷ The amendment was passed.

⁹⁸ Note that in addition to immigration's distributive consequences for natives and immigrants in the receiving country, it has an impact on the welfare of sending states. Consequently, changes in immigration policy can be influenced by international relations considerations. One mechanism for sending states to influence policy is through their immigrant communities.

- *Black Population.* Representatives in districts with more African Americans should, all else equal, be more supportive of liberal policies again particularly for family-based immigration.
- *Economic Activity.* Representatives in districts with industries that employ less-skilled workers intensively should also be more supportive of liberal immigration policies. The employers in these districts may prefer reforms that allow for more employment-based immigration but the current regime characterized by family-based immigration does predictably supply the less-skilled workers these industries demand. However, representatives in districts with lots of activities in high-technology sectors are likely to be more supportive of liberalization only when it includes reforms that actually increase the flow of the skilled workers they require.
- *Organized Labor.* Representatives in districts with higher rates of unionization are likely to be more responsive to the views of organized labor on immigration policy. Although labor has traditionally opposed immigration because of its potential to put downward pressure on wages, it developed a more strategic view in the 1990's. Organized labor remains generally opposed to employment-based immigration liberalization. However, some important labor organizations have become more supportive of family-based immigration. At the very least unions cannot be counted on as consistent restrictionist voices in the immigration debate. The reasons for this distinction lie in the success of unions in recruiting recent immigrant workers. Many unions believe that their long-term interests are served in alliance with rather than in opposition to immigrants and the groups that represent them.⁹⁹ The implications for congressional voting then are that representatives in districts with high unionization are more likely to take a negative view toward liberalizing employment-based immigration but more likely to be supportive of the current family-based policy regime.
- *Less-skilled Workers.* Not all less-skilled workers are union members and even among those that are members, they may not share the long-term strategic partnership views of union leaders. Moreover, the public opinion evidence suggests that these individuals have distinctly more restrictive preferences about immigration. Consequently, this is a diffuse group whose preferences may affect the calculations of members of Congress. We expect

that, all else equal, representatives in districts with higher concentrations of less-skilled workers are more likely to take restrictionist positions on legislation.

- *Political Conservatism.* The public opinion evidence suggests that voters are generally concerned about the fiscal effects of immigration. Moreover, political conservatives who typically favor a smaller welfare state have significantly more restrictive policy opinions about immigration. This suggests that congressional representatives in conservative districts are likely to be more supportive of restrictive legislation. This will be especially true of legislation dealing with family-based immigration and the access of immigrants more generally to public services and the welfare state. We have emphasized the connections between ideological conservatism and views about the welfare state and immigration policy. This is consistent with considerable empirical evidence that the main dimension of ideological political competition in the U.S. over the last several decades is about the size of government and the extent of redistribution.¹⁰⁰ Nonetheless, fiscal conservatism and nativist sentiments are correlated to some degree and the measures of ideology available may also indicate differences in views about the cultural impact of immigrants in addition to the distributive conflicts we have emphasized.¹⁰¹

We analyzed the impact of various measures of these factors on congressional votes on the Chrysler amendment. We found evidence that representatives from districts with more immigrants, blacks, and union members were more likely to vote for the Chrysler amendment and thus prevent restrictive reforms of current legal immigration laws. Districts with more less-skilled workers and more conservative House members were less likely to vote for the amendment. Table 6.2 reports the key results assessing the impact of increasing the variable measuring each factor from typical low values—one standard deviation below their sample means—to typical high values—one standard deviation above their sample means—on the probability of voting *against* the Chrysler amendment.¹⁰² Immigration population is measured by the percent of the total population in the Congressional district that is foreign born. Increasing

⁹⁹ There are no doubt tensions in this calculation as the distinction between employment and family-based immigration for the potential labor market impacts on low-skilled workers is minimal. Family-based immigration means more low-skilled workers.

¹⁰⁰ See, for example, Poole and Rosenthal (1991, 1997).

¹⁰¹ See Kessler (1999) for further discussion of the content of ideological and partisan differences in policy preferences about immigration policy.

¹⁰² The dependent variable was coded as votes against the amendment so it is consistent with the public opinion and other results discussed in this section—more restrictionist opinions and votes are assigned higher values.

this measure from a low value to a typical high value—two standard deviations—decreases the probability that the representative of that district takes a restrictive position and votes against the amendment by 9%. A similar effect is estimated for the percentage of the total population that is African American, but this estimate is less precise. These results are broadly consistent with the observation that these groups are more supportive of the current family-based immigration regime and oppose restrictive reforms. These groups are relatively well organized and it is not surprising that, all else equal, representatives appear to be influenced by their concerns.

Economic activity or the interests of employers is measured in this analysis by the percentage of total district employment in manufacturing. In results not reported, we included alternative measures such as the percentage of employment in agriculture and the percentage of total campaign receipts received by the representative from corporations. For none of these measures is the effect significantly negative as hypothesized. This null result may be because of limitations with these measures. It is clear from immigration debates that employer interests are weighed heavily in U.S. policymaking whether or not they account for differences in voting patterns across legislators not explained by the other variables in all congressional votes. We will discuss congressional voting evidence below for which these measures of district employer interests do have the hypothesized negative effect.

The estimates in Table 6.2 are consistent with our expectation that for some types of policy votes organized labor and less-skilled workers may exert opposing pressures on national policymakers. Consistent with the observation that national union leaders have become more supportive of family-based immigration, increasing unionization from relatively low to relatively high levels decreased the probability the representative took the restrictionist position on this vote by 14%. In contrast, members of Congress in districts with more less-skilled workers—as measured by the percentage of the population above the age of twenty-five with less than a high-school education—were, all else equal, more likely to cast restrictionist votes and the magnitude of the effect was comparable in absolute value to that of unionization. Part of the answer to the question of who resisted the efforts of immigrant, civil rights, and other groups to prevent restrictionist reform of legal immigration is members of Congress that anticipated potential negative electoral consequences from less-skilled workers.

Our analysis suggests that opposition was also ideological. The measure of ideology used is the Poole-Rosenthal NOMINATE score (Poole and Rosenthal 1991, 1997). This variable is

based on the voting behavior of members of the House of Representatives throughout each Congress. Strictly speaking, the variable measures the ideology of each representative. Under most theories of representation, including a median voter model, each member's ideology should be at least sensitive to that of his or her district. Like any multidimensional scaling technique, the actual content of NOMINATE scores is open to interpretation. Poole and Rosenthal argue that the single dimension measure used in this analysis reflects primarily economic conflict between liberals and conservatives over among other things the size of government and the extent of redistribution.¹⁰³ Consequently, we employ this measure to account for differences among districts and representatives in views about the welfare state. The variable is increasing in conservatism. The estimate reported in Table 6.2 indicates that increasing this ideological measure from a typically liberal value—one standard deviation below the mean—to a typically conservative value—one standard deviation above the mean—increases the probability of taking a restrictionist position and voting against the amendment by 30%. This finding is consistent with the ideological differences that we observed among individuals in opinions about immigration policy.

One strategy for checking these results is to examine the determinants of votes for which a particular aspect of immigration policymaking is clearly salient. For example, do the coalition patterns observed over the Chrysler amendment hold up when the legislation in question is explicitly about immigrant access to public services? To some extent we would expect the answer to be yes because we have argued that the coalitions for and against family-based immigration are, in part, determined by the perceived effects of immigration on the welfare state. We analyzed votes in the 104th Congress on passage of a bill to permit states to bar illegal immigrants from public education.¹⁰⁴ The results of the statistical analysis are reported in the Appendix. We again find that representatives in districts with high concentrations of immigrants are significantly less likely to cast restrictionist votes. Further, representatives in districts with relatively more less-skilled workers are again more likely to take restrictionist positions as are members of Congress in ideologically conservative districts. Not surprisingly, in this analysis the

¹⁰³ Although this makes the variable a suitable measure for fiscal conservatism, alternative interpretations are that it is primarily measuring partisan effects (to the extent this is an exogenous explanatory variable) or that it is primarily measuring nativist sentiment. Partisan interpretation is consistent with the main point made here because empirically the primary differences between the U.S. political parties in legislative behavior have been about the size of government and extent of redistribution. Gimpel and Edwards (1999) and Kessler (1999) both emphasize the importance of partisan conflict over immigration policy and their evidence is consistent with fiscal conservatism constituting the substance of those partisan differences.

¹⁰⁴ The bill was passed despite presidential opposition.

magnitude of the effect of the ideological conservatism is even larger than for the Chrysler amendment. When public services is the issue in immigration debates, the positions taken are substantially determined by the preferences that voters and legislators have about the welfare state generally.

Although the expected coalitions for votes about restrictionist reforms to the current family-based policy regime and for votes explicitly about immigration and public services are similar, this is not the case when liberalization of employment-based immigration is the issue in question. First, organized labor is opposed to these forms of liberal immigration policy. Consequently, the tension between organized labor and less-skilled workers should disappear with both groups in opposition to liberalization. Second, ideological differences may shift substantially especially if the legislation is about temporary workers. In particular, ideological liberals can be expected to protect their base labor constituency. Third, we might expect the influence of employer interests to be more apparent when the legislation is specifically about employment-based immigration. To test how the salience of employment issues affects political conflict over immigration policy, we analyzed votes on a motion in the 104th Congress to recommit legislation to the House Judiciary Committee to require certain limitations on replacing U.S. workers with temporary foreign workers.¹⁰⁵ The results of the statistical analysis are reported in the Appendix. Representatives in districts with higher concentrations of immigrants remain less likely to support any restrictive policies including measures making it more difficult to employ temporary foreign workers. The expected reversal of the impact of unionization is apparent in the results with members of Congress from more unionized districts more likely to support restrictions on temporary foreign workers. Similarly, ideological conservatism is now associated with less support for the restrictionist position. Interestingly, the concentration of less-skilled workers no longer has a systematic impact on votes, controlling for the other factors. While this variable has the expected positive correlation when regressed on this congressional vote absent control variables, once organized labor and liberals in Congress—less-skilled workers' natural ideological representatives—take positions consistent with the economic interests of less-skilled workers, the concentration of these workers no longer has a marginal effect on the votes of representatives. Finally, the influence of employers is evident in this analysis with members of Congress in districts with greater manufacturing employment (and

¹⁰⁵ The motion was rejected.

greater campaign contributions from corporations) being less likely to cast votes for further restrictions on hiring foreign temporary workers.

The foregoing discussion illustrates the plausibility of the argument that the relative strength of both organized and diffused groups in each member's congressional district account for variation in voting behavior in the House of Representatives. The arguments resonate with many of the findings in recent comprehensive studies of Congressional immigration policymaking by Gimpel and Edwards (1999) and Kessler (1999). Nevertheless, the results reported here reflect the analysis of a small number of votes in a single Congress and so must be taken with some caution.

6.3 Summary

In this section, we have identified the preferences of the main actors in the U.S. immigration debate and how successful those actors are in influencing national policymakers. Our analysis shows that political conflict over immigration policy has a number of important dimensions and that both organized and diffuse interests influence policymaking. From the opinions of individual citizens about policy to votes on legislation by members of Congress, it is clear that the politics of immigration policymaking is affected by the perceived economic consequences of policy alternatives and, in particular, on the distribution of these economic effects. Less-skilled workers are more likely to support restrictionist policies while employers of these workers generally favor liberalization. The influence of both these groups is observable in the voting behavior of members of Congress. Our evidence also demonstrates that other considerations such as beliefs about the impact of immigration on the welfare state play an important role in the course of policymaking. We observe, for example, consistent opposition to family-based immigration from political conservatives both in the electorate and in Congress. We also find clear preferences among identifiable groups such as immigrants and their children that likely impact the electoral strategies of national politicians. As the previous sections have suggested, immigration has the potential to have substantial effects on a number of key aspects of the nation's political economy including outcomes in the labor market and the size of the welfare state. The politics of immigration policymaking reflects conflict among groups with very different interests and preferences about these issues.

Appendix

Determinants of Immigration Policy Preferences

The simulations reported in Table 6.1 examining the impact of individual skill levels on the probability of supporting further immigration restrictions are based on our statistical analysis of the determinants of immigration preferences. The dependent variable for this analysis is from the NES question about immigration-policy preferences: “Do you think the number of immigrants from foreign countries who are permitted to come to the United States to live should be increased a little, increased a lot, decreased a little, decreased a lot, or left the same as it is now?” We construct the variable *Immigration Opinion* by coding responses 5 for those individuals responding “decreased a lot” down to 1 for those responding “increased a lot.” Thus, higher levels of *Immigration Opinion* indicate preferences for more-restrictive policy. To test whether skill levels are a key determinant of policy preferences, for each individual-year observation we constructed two variables measuring skills. One was *Education Years*, recorded in the NES survey as years of education completed. The other was *Occupation Wage*, which was that year’s average weekly wage nationwide for the three-digit Census Occupation Code occupation reported for the individual. Educational attainment is a common skills measure; *Occupation Wage* assumes that average national earnings for a given occupation are determined primarily by the skills required for that occupation. We also constructed several measures of possible non-economic determinants of preferences. These measures include variables such as gender; age; race; ethnicity; personal immigrant status; party identification; and political ideology.

The empirical work aims to test how skills affect the probability that an individual supports a certain level of legal immigration. The level of immigration preferred by a respondent could theoretically take on any value, but the NES data report only which of five ordered categories the respondent chose. Because there is no strong reason to think *ex ante* that these five ordered categories are separated by equal intervals, a linear regression model might produce biased estimates. The more appropriate model for this situation is an ordered probit, which estimates not only a set of effect parameters but also additional parameters representing unobserved category thresholds.

Given these considerations, we estimate ordered probit models where the expected mean of the unobserved preferred immigration level is hypothesized to be a linear function of the respondent’s skills, a vector of demographic identifiers, and political orientation. Each year of data is analyzed separately to allow for any differences across years and further details about data definitions, estimation procedures including the methods used to deal with missing data problems, and results can be found in Scheve and Slaughter (2001a, 2001b). Appendix Table A6.1 reports the main ordered probit results on which the simulations in Table 6.1 are based.

Determinants of Congressional Votes on Immigration Policy

The simulations reported in Table 6.2 examining the impact of various congressional district characteristics on the probability of voting against the Chrysler amendment are based on our statistical analysis of the determinants of voting on this amendment. The dependent variable is equal to 1 if the representative voted against the amendment and 0 if they voted for it. Thus, a 1 or a success indicates favoring restrictive reforms. The independent variables constructed to

explain the votes are described in the text, and the statistical model estimated was a logit regression with heteroskedastic consistent standard errors. Appendix Table A6.2 reports the logit results on which the simulations in Table 6.2 are based. Appendix Table A6.2 also reports the logit regression estimates for two other congressional votes for which the results are discussed in the main text. The dependent variable for the first is equal to 1 if the representative voted for passage of the bill to permit states to bar illegal immigrants from public education and 0 if they voted against. The dependent variable for the second of these analyses is equal to 1 if the representative voted for motion to recommit legislation to the House Judiciary Committee to require certain limitations on replacing U.S. workers with temporary foreign workers and 0 if they voted against.

7. Conclusion

Setting immigration policy in any country raises a dizzying array of interrelated questions. Immigration may have substantial implications for the economic welfare of both those countries that send immigrants and those that receive them. Aggregate impacts are just a starting point, however, as many of immigration's biggest effects are distributive. The interests of native citizens can conflict with those of immigrants; in addition, interests can conflict among different groups of natives. These distributive battles have always been a feature of the politics and economics of immigration. However, the rise of the modern welfare state has introduced new sources of economic conflict and cooperation that substantially alter how individuals perceive immigration affecting their interests.

To this mix of economic issues is added the political issues of citizenship, national identity, and international relations. Choosing immigration policy requires countries to answer difficult questions about the definition of and requirements for membership in a political community. In answering these questions, racial and ethnic conflict often arises because immigrants are, by definition, from different communities. An immigrant's decision to leave his or her country of birth is one with substantial costs and risks. More often than not, it is a decision born of economic and political instability in the home country. Consequently, immigration policy helps define a nation's strategy both for responding to political repression around the world and also for addressing the acute poverty that often accompanies such instability.

With all this at stake, there is every reason to expect substantial variation across countries and over time both in immigration policy and also in what aspects of the immigration political debate are most salient. Some of this variation is likely to be systematic and predictable. For example, different countries have very different national histories of settlement and colonialism. Those countries with long histories of immigration may or may not be more welcoming to new immigrants, but they are unlikely to spend much time debating whether immigration is in principle consistent with their understanding of citizenship. Differences in political institutions are also likely to account for some systematic variation in the policies and politics of immigration. These institutions can affect the costs and benefits of alternative political strategies for various groups in society (e.g., interest-group versus electoral politics).

To explain all this variation in immigration policymaking in receiving states, a sensible first step is a detailed account of each country's immigration experience. In this document, we

have produced such an account for the United States. We have evaluated recent patterns in the flows of immigrants, the policies governing those flows, and the effects of those flows on the U.S. economy. We conclude that the ongoing debate about U.S. immigration policy is likely to center on three issues: the level and composition of immigration, the public-finance impact of immigration, and how to control illegal immigration. We briefly summarize key findings for each of these three issues.

Concern about the level and composition of immigration derives partly from the perception that less-skilled immigrants hurt low-wage U.S. workers and increase fiscal transfers from natives to immigrants. While less-skilled U.S. workers are among those most opposed to freer immigration, which is consistent with the idea that unskilled immigration is bad for their livelihood, there is little evidence that immigration has significantly reduced the wages of U.S. native workers. This is surprising, perhaps, as the U.S. economy is commonly thought to have high wage flexibility, at least relative to European and other advanced economies.

U.S. regions appear to have absorbed immigrant inflows through mechanisms other than wage (or unemployment) changes, including changes in native migration patterns, shifts in industry composition, and skill upgrading of natives. This last mechanism may be less important in coming decades, as the educational composition of the U.S. labor force is projected to stabilize. Should this happen, future immigration may be more harmful to the economic well-being of less-skilled U.S. natives. This expectation might explain the support of less-skilled natives (and their political advocates) for greater immigration restrictions.

As for immigration and public assistance, some have argued that frequent immigrant take-up of public assistance contributed during the 1990s to a legislative backlash. Some early reforms, such as California's Proposition 187, were blocked by the courts. But in 1996 the U.S. Congress passed a sweeping reform of federal welfare programs, aimed at curtailing access of immigrants—recent immigrants in particular—to many public benefits. Fiscal conservatives tended to support these restrictions, consistent with their preferences to reduce the size of government and redistributive transfers. The outcry over immigrant public support is somewhat surprising in light of the fact that net fiscal transfers from natives to immigrants appear to be very small. Moreover, what transfers there are are mainly for public education, a program with wide political support to which immigrants and their children will likely continue to have access. The

size of net fiscal transfers does vary across states, however, which may help explain the push for immigrant welfare reform in these states (e.g., California and New York).

One important feature of recent U.S. welfare reform is devolution: states were granted more discretion over the level of welfare benefits, in general, and whether immigrants have access to specific programs, in particular. Devolution has reduced the federal government's ability to coordinate a national policy over the attractiveness of the United States as an immigrant destination. This moves the United States closer to the situation of the European Union, within which countries differ considerably in the generosity of their welfare systems. Some U.S. states, such as Massachusetts, have committed to replace lost federal benefits for immigrants. Others, such as California, offer more generous welfare programs of one kind or another. Cross-state variation in immigrant access to public assistance may contribute to the continued geographic concentration of immigrant populations in specific U.S. regions.

The third key area in which U.S. immigration policy has changed over the last two decades is enforcement against illegal immigration. The U.S. government has dramatically increased expenditure on enforcement against illegal entry at the Mexico-U.S. border, raised penalties for hiring illegal aliens, and broadened monitoring of employers deemed likely to hire illegal aliens. These reforms have increased border enforcement at specific points where illegal crossing has been particularly heavy in the past. But enforcement has been slow to increase at other points along the border, which perhaps accounts for why the net inflow of illegal aliens does not appear to have diminished. Illegal migrants change their border crossing behavior very quickly in response to changes in enforcement. This renders operations in specific border regions relatively ineffective at curtailing overall illegal immigration.

Despite widely publicized legislation in the 1980s that increased sanctions against hiring undocumented workers, the U.S. government seems reluctant to monitor intensively U.S. employers. Many illegal aliens responded to new sanctions simply by obtaining fake documents, which employers often accept at face value. The hiring of illegal aliens—though not technically of 'undocumented' workers—remains widespread in many labor-intensive industries, particularly in the Western United States. The U.S. government focuses the vast majority of its efforts against illegal immigration on the border, where illegal migrants, and not U.S. employers, bear the direct costs of enforcement. These enforcement practices appear to be at least partly a response to pressure from farmers and employers in other labor-intensive sectors, who strongly

oppose policing of their hiring practices. A resumption of large-scale temporary immigration of manual laborers is being proposed as an alternative to even greater enforcement against illegal immigration. Expanded temporary immigration enjoys the support of employers and the Mexican government, but may be opposed by labor unions and some immigrant and civil-rights groups.

To summarize, the U.S. experience in recent decades is one of sharply rising levels of immigration; a shift in the composition of immigrants towards individuals from Asia and Latin America, who tend to have less schooling than U.S. natives; an increase (at least until the welfare reforms of 1996) in the use of means-tested welfare benefits by immigrants; and a substantial rise in illegal immigration. Against this background, immigration debates have quite naturally focused on the level and composition of immigration, whether immigrants should have access to public assistance, and how to control illegal immigration. A common theme underpinning these debates has been distributive conflict. The economic interests of employers, workers, and taxpayers have helped shape the policy preferences and political strategies for immigration policymaking in the United States. Immigration debates have, of course, been marked by other concerns; in particular, those that mobilize nativist sentiments for cultural homogeneity. It is not clear, however, whether non-economic forces have had substantial influence in national policymaking. In contrast, the role of economic interests and the building of strategic coalitions to protect those interests is evident at all levels of debate and political activity about immigration in the United States.

In this environment, the United States faces several important choices with regards to immigration policy. Key decisions include whether to replace family-based immigration with skills-based immigration, whether to continue to exclude immigrants from access to public assistance, whether to expand temporary immigration, and how to balance border and interior policing in enforcing against illegal immigration. In closing, we briefly address each of these policy choices.

U.S. immigration policies based on family reunification have been associated with rising immigration of the less skilled. An alternative policy would be to admit immigrants based on their human capital. A shift in immigration policy to favor the admission of young, highly skilled workers might tend to reduce any negative impacts of immigration on low-skilled native workers, enhance the U.S. comparative advantage in knowledge-intensive industries, and generate positive

net fiscal transfers from immigrants to natives. The first two effects would operate through labor supply. Increasing the relative supply of more-skilled workers may increase the wages of less-skilled workers, in both relative and real terms. A larger supply of more-skilled labor would also tend to shift the pattern of specialization towards industries that use this factor intensively, including high-technology sectors, finance, and business services. The third effect, of reversing net fiscal transfers from natives to immigrants, reflects the fact that young, highly educated immigrants have had their schooling financed abroad and stand to make U.S. tax contributions over most of their working life. Given their high earnings ability, these individuals are also unlikely to use public assistance.

To the extent U.S. objectives in setting immigration policy are to soften the economic impact on low-skilled natives, strengthen the country's position in knowledge-intensive industries, and avoid fiscal transfers from natives to immigrants, replacing family-based immigration with skills-based immigration is a logical choice. Skills-based immigration might have several important limitations relative to these objectives, however. One is simply that the presumed impacts on less-skilled wages and fiscal transfers might be quite small. As we have documented, there is very little evidence that less-skilled immigrants in recent decades have had large impacts on less-skilled wages and fiscal transfers. By implication, the same small effects might be expected after a policy switch towards more-skilled immigrants.

A second limitation is that favoring young, highly skilled immigrants may contribute to "brain drain" from poorer countries, which might undermine development prospects in such countries. Many in the United States might prefer to replace low-skilled immigrants with engineers from China and India, but the Chinese and Indian governments might oppose such a policy change.

And a third limitation is that in the long run, the distinction between skills and family-based immigration policies may not be so sharp. Given political pressures from immigrant and civil rights groups and the U.S. tradition of family-based immigration, the United States may find it difficult to admit only skilled individuals and not their less-skilled family members. The admission of one highly skilled individual may lead to the admission of four or five individuals in total, with varying skill levels. This suggests that skills-based immigration might raise the skill composition of new immigrants relative to family-based immigration by less than is commonly presumed.

To limit fiscal transfers to immigrants, an obvious alternative policy would be to expand laws that directly exclude immigrants from access to public assistance. However, recent U.S. examples demonstrate that such legislative exclusions are often challenged judicially, with courts limiting or even overturning these laws. More broadly, there is ongoing discussion as to whether excluding immigrant access to public assistance may violate the equal-protection clause of the U.S. Constitution. Public education is again a vivid example. The largest transfer most immigrants receive is in the form of public education, to which it is both politically and legally difficult to restrict the access of immigrants—legal or illegal. All this suggests that a more effective means of limiting immigrant fiscal transfers might be the indirect method of admitting immigrants who are likely to make positive net fiscal contributions—e.g., the more-skilled.

A switch from family to skills-based immigration may also alter the behavior of illegal immigrants. Individuals who find themselves cut off from opportunities for legal immigration, such as less-skilled relatives of U.S. residents, may choose to immigrate illegally. This switch may therefore increase attempts at illegal immigration. If the U.S. objective is to not increase illegal immigration, then complementary policies are needed. That said, the recent tide of illegal immigrants into the United States suggest that the overall number of illegals has not been greatly affected by the current U.S. policy mix of heavy border enforcement, light interior enforcement, and low levels of temporary immigration of manual laborers.

To reduce the total inflow of illegals, one policy option might be to increase temporary immigration of manual laborers—e.g., to a level roughly equal to the current level of illegal immigration. This would seek to replace an unregulated, long-run supply of illegal workers with a regulated, short-run supply of legal workers. In theory, large-scale temporary immigration would curtail illegal immigration if U.S. firms viewed illegal workers and temporary legal workers as close substitutes and if potential migrants viewed temporary migration as reasonably comparable to illegal migration. There are reasons to doubt that this latter condition holds. An increasing fraction of illegal immigrants live and work in cities. They have long-term relationships with employers and an established presence in their communities. Temporary immigration precludes such permanence, precarious as it may be. For some migrants, then, temporary immigration may be an inferior option to illegal immigration.

Even if temporary immigration were to succeed in reducing illegal immigration, the question remains of what objective would have been achieved. If temporary immigrants and

illegal immigrants translate into roughly the same shift in relative labor supplies, then they will have roughly the same impacts on wages and industry mix. And the impact of the two inflows on fiscal balances may also be roughly similar. Temporary immigrants would likely have access to certain restricted benefits in the United States, but they would also pay income taxes on their labor income. Illegal immigrants are barred from receiving public assistance, but are entitled to receive emergency medical care and to send their children to public schools. They also appear to make sizable contributions to social insurance coffers, on which they do not collect.

To reduce the total inflow of illegals, a different policy option would be to increase employer monitoring. U.S. law forbids firms from hiring illegal aliens, but enforcement appears to be lax. Firm visits by the Immigration and Naturalization Service are often announced in advance, and fines for violations are small and infrequently applied. Demand for illegal labor could be reduced by conducting random, unannounced worksite inspections and by levying much larger fines. In turn, this lower demand might reduce illegal entry, as lower wages and/or lost jobs would dissuade prospective migrants from attempting to cross the border. The main obstacle to greater employer monitoring appears to be intense and highly organized political opposition by employers.

It appears that wide-ranging reform of U.S. immigration policy is unlikely in the near future, thanks to the interaction of various constituencies. But as the process of U.S. welfare reform in the mid-1990s demonstrates, pressure and consensus for large policy changes can build very quickly. Our discussion has aimed to clarify how different immigration policies present different trade-offs across different policy objectives.

References

- Acemoglu, Daron. 1999. "Patterns of Skill Premia." NBER Working Paper No. 7018.
- Alt, James E., and Michael Gilligan. 1994. "The Political Economy of Trading States." *Journal of Political Philosophy* Vol. 2:165-192.
- Altonji, Joseph, and David Card. 1991. "The Effects of Immigration on the Labor Market Outcomes of Less-Skilled Natives." In John Abowd and Richard Freeman, eds, *Immigration, Trade, and the Labor Market*, (Chicago, IL: University of Chicago Press): 201-234.
- Arnold, R. Douglas. 1990. *The Logic of Congressional Action*. New Haven, CT: Yale University Press.
- Auerbach, Alan J., and Philip Oreopoulos. 1999. "Analysing the Fiscal Impact of U.S. Immigration." *American Economic Review. Papers and Proceedings*, 89(2), pp. 176-180.
- Autor, David H., Lawrence F. Katz, and Alan B. Krueger. 1998. "Computing Inequality: Have Computers Changed the Labor Market?" *Quarterly Journal of Economics*: 1169-1214.
- Bailey, Michael. 1999. "The Other Side of the Coin: The Hidden Benefits of Campaign Finance." Georgetown University Manuscript.
- Bailey, Michael. 2001. "Quiet Influence: The Representation of Diffuse Interests on Trade Policy, 1983-94." *Legislative Studies Quarterly* Vol. XXVI No. 1 (February):45-80.
- Bean, Frank D., B. Lindsay Lowell, and Lowell J. Taylor. 1988. "Undocumented Mexican Immigrants and the Earnings of Other Workers in the United States," *Demography* 25, 35-52.
- Bean, Frank D., Roland Chanove, Robert G. Cushing, Rodolfo de la Garza, Gary P. Freeman, Charles W. Haynes, and David Spencer. 1994. "Illegal Mexican Migration and the United States/Mexico Border: The Effects of Operation Hold the Line on El Paso/Juarez," U.S. Commission on Immigration Reform Research Paper (July 1994).
- Berman, Eli, John Bound, and Zvi Griliches. 1994. "Changes in Demand for Skilled Labor Within U.S. Manufacturing Industries." *Quarterly Journal of Economics*, 109, pp. 367-398.
- Bernstein, Jeffrey R. and David E. Weinstein. 1998. "Do Endowments Predict the Location of Production? Evidence from National and International Data." NBER Working Paper No. 6815.
- Blanchard, Olivier J., and Lawrence F. Katz. 1992. "Regional Evolutions." *Brookings Papers on Economic Activity*, pp. 1-61.
- Blank, Rebecca M. 1997. "The 1996 Welfare Reform." *Journal of Economic Perspectives*, 11(1). Winter.

Blau, Francine D. 1984. "The use of transfer Payments by Immigrants," *Industrial and Labor Relations Review*, 37, pp. 222-39.

Borjas, George J. 1994. "The Economics of Immigration." *Journal of Economic Literature* 32: 1667-1717.

Borjas, George J. 1995a. "Immigration and Welfare" *Research in Labor Economics*, 14, pp. 253-282.

Borjas, George J. 1995b. "Know the Flow" *National Review*. April 17.

Borjas, George J. 1996. "The Earnings of Mexican Immigrants in the United States." *Journal of Development Economics* 51: 69-98.

Borjas, George J. 1999a. *Heaven's Door: Immigration Policy and the American Economy*. Princeton, N.J.: Princeton University Press.

Borjas, George J. 1999b. "The Economic Analysis of Immigration." In Orley C. Ashenfelter and David Card, eds., *Handbook of Labor Economics*, Amsterdam: North-Holland, pp. 1697-1760.

Borjas, George J. 1999c. "Immigration and Welfare Magnets." *Journal of Labor Economics*, 17(4). 607-37.

Borjas, George J., ed. 2000. *Issues in the Economics of Immigration*. Chicago: The University of Chicago Press.

Borjas, George J., Stephen G. Bronars, and Stephen J. Trejo. 1992. "Self-Selection and Internal Migration in the United States." *Journal of Urban Economics*, September: 159-185.

Borjas, George J., Richard B. Freeman, and Lawrence F. Katz. 1996. "Searching for the Effect of Immigration on the Labor Market." *American Economic Review* 86 (2): 247-251.

Borjas, George J., Richard B. Freeman, and Lawrence F. Katz. 1997. "How Much Do Immigration and Trade Affect Labor Market Outcomes?" *Brookings Papers on Economic Activity* 1: 1-90.

Borjas, George J., and Lynette Hilton. 1996. "Immigration and the Welfare State: Immigrant Participation in Means-Tested Entitlement Programs" *Quarterly Journal of Economics*, 111(2), pp. 575-604.

Borjas, George J., Freeman, Richard B. and Lang, Kevin. "Undocumented Mexican-Born Workers in the United States: How Many, How Permanent?" in John M. Abowd and Richard B. Freeman, eds., *Immigration, Trade, and the Labor Market*. Chicago, IL: University of Chicago Press, 1991, pp. 77-100.

Borjas, George J. and Stephen J. Trejo. 1991. "Immigrant Participation in the Welfare System," *Industrial and Labor Relations Review*, 44, pp. 195-211.

Bound, John, and Harry Holzer. 1996. "Demand Shifts, Population Adjustments, and Labor Market Outcomes during the 1980s." National Bureau of Economic Research Working Paper #5685, July.

Bound, John and George Johnson. 1992. "Changes in the Structure of Wages in the 1980s: An Evaluation of Alternative Explanations." *American Economic Review*: 371-392.

Brueckner, Jan K. 2000. "Welfare Reform and the Race to the Bottom: Theory and Evidence," *Southern Economic Journal*, 66(3), pp. 505-525.

Bustamante, Jorge A., Guillermina Jasso, J. Edward Taylor, and Paz Trigueros Legarreta. 1998. "Characteristics of Migrants: Mexican in the United States." In Mexico-United States Binational Migration Study, pp. 91-162.

Butcher, Kristin F. and Anne Morrison Piehl. 2000. "The Role of Deportation in the Incarceration of Immigrants." In George J. Borjas, ed., *Issues in the Economics of Immigration*, Chicago: University of Chicago Press, pp. 351-386.

Calavita, Kitty. *Inside The State: The Bracero Program, Immigration, and The I.N.S.* New York, NY: Routledge, 1992.

Camarota, Steven A. 2001. "Immigrants in the United States – 2000." Mimeo, Center for Immigration Studies (<http://www.cis.org/>).

Card, David. 1990. "The Impact of the Mariel Boatlift on the Miami Labor Market." *Industrial and Labor Relations Review* 43 (2): 245-257.

Card, David. 2001. "Immigrant Inflows, Native Outflows, and the Local Labor Market Impacts of Higher Immigration." *Journal of Labor Economics*, 19 (1): 22-64.

Chiswick, Barry R. 1984. "Illegal Aliens in the United States Labor Market: Analysis of Occupational Attainment and Earnings." *International Migration Review* 28(3): 714-732.

Citrin, Jack, Donald Green, Christopher Muste, and Cara Wong. 1997. "Public Opinion Toward Immigration Reform: The Role of Economic Motivation." *Journal of Politics* Vol. 59 No. 3:858-881.

Cornelius, Wayne A. 1992. "From Sojourners to Settlers: The Changing Profile of Mexican Immigration to the United States," in Jorge A. Bustamante, Clark W. Reynolds, and Raul A. Hinojosa, eds., *U.S.-Mexico relations: labor-market interdependence*. Stanford, CA: Stanford University Press, pp. 155-95.

Cornelius, Wayne A. 2000. "Death at the Border: The Efficacy and "Unintended" Consequences of U.S. Immigration Control Policy, 1993-2000." Center for Comparative Immigration Studies Working Paper No. 27.

Cornelius, Wayne A. and Enrico A. Marselli. 2001. "The Changing Profile of Mexican Migrants to the United States: New Evidence from California and Mexico." *Latin American Research Review*, forthcoming.

Crane, Keith W.; Asch, Beth J.; Heilbrunn, Joanna Z. and Cullinane, Danielle C. 1990. "The Effect of Employer Sanctions on the Flow of Undocumented Immigrants to the United States." Washington, D.C.: Urban Institute Report 90-8.

Currie, Janet. 2000. "Do Children of Immigrants make Differential Use of Public Health Insurance?" in Borjas, George J. editor, *Issues in the Economics of Immigration*, Chicago, IL: The University of Chicago Press.

Davis, Donald R. 1998. "Does European Unemployment Prop Up American Wages? National Labor Markets and Global Trade." *American Economic Review* 88 (3), June: 478-494.

Davis, Donald R., and David E. Weinstein. 1998. "An Account of Global Factor Trade." National Bureau of Economic Research Working Paper No. 6785.

Denzau, Arthur, and Michael Munger. 1986. "Legislators and Interest Groups: How Unorganized Interest Get Represented." *American Political Science Review* Vol. 80:89-102.

Donato, Katharine M., Jorge Durand, and Douglas S. Massey. 1992. "Stemming the Tide? Assessing the Deterrent Effects of the Immigration Reform and Control Act." *Demography* 29(2): 139-157.

Durand, Jorge. 1996. "Migradollars and Development: A Reconsideration of the Mexican Case." *International Migration Review* 30(2): 423-445.

Durand, Jorge and Douglas S. Massey. 1992. "Mexican Migration to the United States: A Critical Review." *Latin American Research Review*.

Durand, Jorge, Douglas S. Massey, and Rene M. Zenteno. 2001. "Mexican Immigration in the United States." *Latin American Research Review* 36(1): 107-127.

Elwood, David T. 2001. "The Sputtering Labor Force of the 21st Century: Can Social Policy Help?" Mimeo, January.

Espenshade, Thomas J. 1994. "Does the Threat of Border Apprehension Deter Undocumented U.S. Immigration?" *Population and Development Review*, December, 20(4), pp. 871-91.

Espenshade, Thomas J. 1995. "Unauthorized Immigration to the United States." *Annual Review of Sociology*, 21, pp. 195-216.

Espenshade, Thomas J., and Katherine Hempstead. 1996. "Contemporary American Attitudes Toward U.S. Immigration." *International Migration Review* Vol. 26 No. 4:1144-1167.

Espenshade, Thomas J., Jessica L. Baraka, and Gregory A. Huber. 1997. "Implications of the 1996 welfare and Immigration Reform acts for US Immigration" *Population and Development Review*, 23(4): 769-801.

Ethier, Wilfred J. 1984. "Higher Dimensional Issues in Trade Theory." In Ronald W. Jones and Peter B. Kenen, eds, *Handbook of International Economics Volume 1*, (Amsterdam: North Holland Press), 131-184.

Fetzer, Joel S. 2000. *Public Attitudes toward Immigration in the United States, France, and Germany*. Cambridge, UK: Cambridge University Press.

Fix, Michael E., and Karen Tumlin. 1997. "Welfare Reform and the Devolution of Immigration Policy." The Urban Institute.

Fix, Michael E., and Jeffrey S. Passel. 1994. "Immigrations and Immigrants. Setting the Record Straight." The Urban Institute.

Fix, Michael E., and Jeffrey S. Passel. 1999. "Trends in Noncitizens' and Citizens' Use of Public Benefits Following Welfare Reform: 1994-97" The Urban Institute.

Fix, Michael E., Jeffrey S. Passel, and Wendy Zimmermann. 1996. "Facts about immigrants' use of welfare." The Urban Institute.

Flier, Randall K. 1992. "The Impact of Immigrant Arrivals on Migratory Patterns of Natives." In George J. Borjas and Richard B. Freeman, eds, *Immigration and the Work Force: Economic Consequences for the United States and Source Areas*, (Chicago, IL: University of Chicago Press).

Friedberg, Rachel, and Jennifer Hunt. 1995. "The Impact of Immigrants on Host Country Wages, Employment, and Growth." *Journal of Economic Perspectives* 9 (2): 23-44.

Gandal, Neil, Gordon H. Hanson, and Matthew J. Slaughter. 2000. "Technology, Trade, and Adjustment to Immigration in Israel." NBER Working Paper No. 7962.

Gaston, Noel and Douglas Nelson. 2001. "Immigration and Labor-Market Outcomes in the United States: A Political-Economy Puzzle." *Oxford Review of Economic Policy* 16.

Gilligan, Michael. 1997. *Empowering Exporters: Reciprocity, Delegation, and Collective Action in American Trade Policy*. Ann Arbor, MI: University of Michigan Press.

Gimpel, James G., and James R. Edwards, J. 1999. *The Congressional Politics of Immigration Reform*. Boston, MA: Allyn and Bacon.

Grier, Kevin, Michael Munger, and B.E. Roberts. 1994. "The Determinants of Industry Political Activity, 1978-1986." *American Political Science Review* Vol. 88:911-26.

Gustman, Alan J., and Thomas L. Steinmeier. 2000. "Social Security Benefits of Immigrants and U.S. Born" in Borjas, George J., editor, *Issues in the Economics of Immigration*, Chicago, IL: The University of Chicago Press.

Hanson, Gordon H., Raymond Robertson, and Antonio Spilimbergo. 2001. "Does Border Enforcement Protect U.S. Workers from Illegal Immigration?" *The Review of Economics and Statistics*, forthcoming.

Hanson, Gordon H. and Matthew J. Slaughter. 2001. "Labor-Market Adjustment in Open Economies: Evidence from U.S. States," *Journal of International Economics*, forthcoming.

Hanson, Gordon H., and Antonio Spilimbergo. 1998. "Mexican Migration and U.S. Policy Options". In *Immigration in U.S.-Mexican Relations*, Peter Hakim and Nora Lustig, eds. Washington, DC: Brookings Institution and Inter-American Dialogue.

Hanson, Gordon H., and Antonio Spilimbergo. 1999. "Illegal Immigration, Border Enforcement and Relative Wages: Evidence from Apprehensions at the U.S.-Mexico Border," *American Economic Review*, 89: 1337-57.

Hanson, Gordon H., and Antonio Spilimbergo. 2001 "Political Economy, Sectoral Shocks, and Border Enforcement," *Canadian Journal of Economics*, forthcoming.

Haskel, Jonathan E., and Matthew J. Slaughter. 2001. "Does the Sector Bias of Skill-Biased Technological Change Explain Changing Skill Premia?", *European Economic Review*, forthcoming.

Johnson, George. 1983. "Intermetropolitan Wage Differentials in the United States." In J. Triplett, ed., *The Measurement of Labor Costs*, Chicago: University of Chicago Press, pp. 309-330.

Johnson, George. 1997. "Changes in Earnings Inequality: The Role of Demand Shifts." *Journal of Economic Perspectives*, 11, pp. 41-54.

Johnson, Hans P. 1997. *Undocumented Immigration to California: 1980-1993*. San Francisco: Public Policy Institute of California.

Juffras, Jason. 1991. "Impact of Immigration Reform and Control Act on the Immigration and Naturalization Service." The RAND Corporation Report JR-09.

Juhn, Chinhui, Kevin M. Murphy, Kevin M., Chin-, and Brooks Pierce. 1993. "Wage Inequality and the Rise in Returns to Skill." *Journal of Political Economy* 101: 410-442.

Katz, Lawrence F. and Kevin M. Murphy. 1992. "Changes in Relative Wages, 1963-1987: Supply and Demand Factors." *Quarterly Journal of Economics*: 35-78.

Kessler, Alan E. 1999. "Globalization, Domestic Politics, and the 'Curious Coalitions' of Postwar American Immigration Reform." Paper presented at the 1999 Annual Conference of the American Political Science Association.

Kingdon, John. 1973. *Congressman's Voting Decisions*. New York: Harper and Row.

Kossoudji, Sherrie A. 1992. "Playing Cat and Mouse at the U.S.-Mexico Border." *Demography* 29(2): 159-180.

LaLonde, Robert and Robert Topel. 1991. "Labor Market Adjustments to Increased Immigration." In John Abowd and Richard Freeman, eds, *Immigration, Trade, and the Labor Market*, (Chicago, IL: University of Chicago Press): 167-200.

Leamer, Edward E., and James Levinsohn. 1995. "International Trade Theory: The Evidence." In Gene M. Grossman and Kenneth Rogoff, eds, *Handbook on International Economics Volume 3*, (Amsterdam: North Holland Press), 1339-1394.

Lee, Ronald; and Timothy Miller. 2000. "Immigration, Social Security, and Broader Fiscal Impact" *American Economic Review. Papers and Proceedings*, 90(2), pp. 350-354.

McCarthy, Kevin F., and Vernez, George. 1998. *Immigration in a Changing Economy. California's Experience – Questions and Answers*. Santa Monica, CA: The RAND Corporation.

Martin, Philip L. 1990. "Harvest of Confusion: Immigration Reform and California Agriculture." *International Migration Review* 24(1): 69-95.

Martin, Philip. 1998. "Guest Workers: Past and Present." In Mexico-United States Binational Migration Study, *Migration Between Mexico and the United States, Volume 3*, Washington, D.C.: U.S. Commission on Immigration Reform and Mexican Ministry of Foreign Affairs, pp. 877-896.

Massey, Douglas S., L. Goldring, and Jorge Durand. 1994. "Continuities in Transnational Migration: An Analysis of Nineteen Mexican Communities." *American Journal of Sociology* 99(6): 1492-1533.

Massey, Douglas S. and Audrey Singer. 1995. "New Estimates of Undocumented Mexican Migration and the Probability of Apprehension." *Demography* 32(2): 203-213.

Mexico-United States Binational Migration Study, *Migration Between Mexico and the United States, Volumes 1, 2, and 3*. (Washington, D.C.: U.S. Commission on Immigration Reform and Mexican Ministry of Foreign Affairs, 1998).

Milner, Helen. 1988. *Resisting Protectionism*. Princeton, NJ: Princeton University Press.

Montgomery, Edward. 1991. "Evidence on Metropolitan Wage Differences across Industries and over Time." *Journal of Urban Economics* 31: 69-83.

OECD. Various Years. "Trends in International Migration." Annual Report. Paris. Various issues.

Olson, Mancur. 1965. *The Logic of Collective Action*. Cambridge, MA: Harvard University Press.

Orrenius, Pia M. and Madeline Zavodny. 2001. "Self-Selection among Undocumented Immigrants from Mexico." Mimeo, Federal Reserve Bank of Dallas.

Poole, Keith, and Howard Rosenthal. 1991. "Patterns of Congressional Voting." *American Journal of Political Science* Vol. 35 No. 1:228-278.

Poole, Keith, and Howard Rosenthal. 1997. *Congress: A Political-Economic History of Roll Call Voting*. Oxford, UK: Oxford University Press.

Rauch, James E. 1993. "Productivity Gains from Geographic Concentration of Human Capital: Evidence from the Cities." *Journal of Urban Economics* 34: 380-400.

Rauch, James, and Victor Trindade. 2001. "Ethnic Chinese Networks in International Trade." *Review of Economics and Statistics*, forthcoming.

Reyes, Belinda I. 1997. *Dynamics of Immigration: Return Migration to Western Mexico*. San Francisco: Public Policy Institute of California.

Robertson, Raymond. 2000. "Wage Shocks and North American Labor-Market Integration." *American Economic Review* 90(4): 742-764.

Rybczynski, T. M. 1955. "Factor Endowments and Relative Commodity Prices." *Economica* 22: 336-341.

Razin, Assaf, Efraim Sadka, and Phillip Swagel. 1998. "Tax Burden and Migration: A Political Economy Theory and Evidence." NBER Working Paper 6734.

Saxenian, AnnaLee. 1999. "Silicon Valley's New Immigrant Entrepreneurs." Public Policy Institute of California Working Paper.

Schattschneider, E. E. 1935. *Politics, Pressure and the Tariff: A Study of Free Private Enterprise in Pressure Politics, as Shown in the 1929-1930 Revision of the Tariff*. Hamden, CT: Archon Books.

Scheve, Kenneth F., and Matthew J. Slaughter. 2001a. "Labor Market Competition and Individual Preferences Over Immigration Policy." *The Review of Economics and Statistics* Vol. 83 No. 1 (February):133-46.

Scheve, Kenneth F., and Matthew J. Slaughter. 2001b. *Globalization and the Perceptions of American Workers*. Washington D.C.: Institute for International Economics.

Sheridan, Mary Beth. 2001. "Illegals paying Millions in Taxes." In Washington Post Sunday April 15.

Simon, Rita J., and Susan H. Alexander. 1993. *The Ambivalent Welcome: Print Media, Public Opinion and Immigration*. Westport: Praeger.

Slaughter, Matthew J. 2000. "What Are the Results of Product-Price Studies and What Can We Learn From Their Differences?" in Robert C. Feenstra (ed), *International Trade and Wages*, National Bureau of Economic Research Conference Volume: 121-170.

Smith, James P. and Barry Edmonston, eds. 1997. *The New Americans: Economic, Demographic, and Fiscal Effects of Immigration*. National Academy Press: Washington, D.C.

Smith, James P., and Barry Edmonston, eds. 1998. *The Immigration Debate*. National Academy Press: Washington, D.C.

Spilimbergo, Antonio. 1999. "Labor Market Integration, Unemployment, and Transfers." *Review of International Economics*, 7(4): 641-650.

Stolper, Wolfgang, and Paul A. Samuelson. 1941. "Protection and Real Wages." *Review of Economics and Statistics* 9 (1): 58-73.

Storesletten, Kjetil. 2000. "Sustaining Fiscal Policy Through Immigration" *Journal of Political Economy*. 108(2).

Topel, Robert H. 1986. "Local Labor Markets." *Journal of Political Economy*, 94, S111-143.

Topel, Robert H. 1994. "Regional Labor Markets and the Determinants of Wage Inequality." *American Economic Review*, pp. 17-22.

U.S. Bureau of the Census, 2000. *Educational Attainment in the United States*, March 1999. Washington, D.C.: U.S. Government Printing Office.

U.S. Immigration and Naturalization Service, Department of Justice. 1998. "Illegal Alien Resident Population." [Http://www.ins.usdoj.gov/](http://www.ins.usdoj.gov/).

U.S. Immigration and Naturalization Service, Department of Justice. 1998 Statistical Yearbook of the Immigration and Naturalization Service. Washington, D.C.: U.S. Government Printing Office, 2000.

Warren, Robert. 1995. "Estimates of the Undocumented Immigrant Population Residing in the United States, by Country of Origin and State of Residence: October 1992." Mimeo, U.S. Immigration and Naturalization Service.

Warren, Robert. 1999. "Unauthorized Immigrants Residing in the United States: Estimating the Population, Components of Change, and Trends, by Broad Area of Origin, 1987 to 1997." Mimeo, U.S. Immigration and Naturalization Service.

Weintraub, Sidney. 1998. "IRCA and the Facilitation of the U.S.-Mexico Migration Dialogue." In Bean et al., Binational Study.

Wildasin, David E. 1994. "Income redistribution and migration" *Canadian Journal of Economics*, 27(3): 637- 656.

Woodruff, Christopher and Rene M. Zenteno. 2001. "Remittances and Microenterprises in Mexico." Mimeo, UC San Diego.

Table 2.1: Changing Skills of Immigrant and Native Populations, 1960-98

	1960	1970	1980	1990	1998
Native men					
Percent who are high school dropouts	53.0	39.7	23.3	11.9	9.0
Percent who are college graduates	11.4	15.4	22.8	26.4	29.8
Percent with at least a master's degree	--	--	--	9.2	9.9
Immigrant men					
Percent who are high school dropouts	66.0	49.0	37.5	34.1	33.6
Percent who are college graduates	10.1	18.6	25.3	26.6	28.3
Percent with at least a master's degree	--	--	--	12.9	12.5
Percent hourly wage differential	4.2	0.0	-9.2	-15.0	-23.0
Between immigrant and native men					
Native women					
Percent who are high school dropouts	46.1	35.3	19.7	9.2	6.6
Percent who are college graduates	9.7	11.5	17.9	23.6	28.5
Percent with at least a master's degree	--	--	--	7.7	8.7
Immigrant women					
Percent who are high school dropouts	61.8	47.9	34.6	25.9	24.5
Percent who are college graduates	5.6	9.7	17.5	23.0	28.7
Percent with at least a master's degree	--	--	--	8.0	8.8
Percent hourly wage differential	3.4	3.0	-1.7	-5.0	-12.1
Betwn immigrant and native women					

Source: Borjas (1999).

Table 2.2:
Sources of Legal Immigration in the United States

	Foreign-Born Pop., 2000		Cohorts by Arrival Year			
	Level (000s)	Percent Distribution	Pre-1970	1970-79	1980-89	1990-99
All Countries	28,379	100.0	4,547	4605	8,022	11,206
			(level in 000s)			
			(percent distribution)			
Mexico	7,858	27.7	15.0	30.2	28.4	31.3
Canada	679	2.4	7.0	1.8	1.1	1.7
Central America	1,948	6.9	3.8	4.6	9.9	6.9
Caribbean	2,815	9.9	13.0	10.7	9.9	8.3
South America	1,876	6.6	4.8	6.2	6.7	7.5
Europe	4,356	15.3	41.3	11.7	8.2	11.4
East Asia	5,085	17.9	9.0	20.2	22.7	17.2
South Asia	1,315	4.6	1.4	4.3	4.4	6.2
Middle East	1,035	3.6	2.4	6.4	3.8	2.9
Sub-Saharan Africa	511	1.8	0.4	1.5	1.9	2.4
Other/Oceania	904	3.2	2.0	2.3	3.1	4.1

Source: Camarota (2001).

Table 2.3: Immigration and Population in U.S. States, 2000

	State Share of		State Share of		Share of Foreign	
	National	Population	Foreign-	Born Pop.	Born in	Population
	1990	2000	1990	2000	1990	2000
California	12.0	12.4	32.7	30.9	21.7	25.9
New York	7.2	6.8	14.4	12.8	15.9	19.6
Florida	5.2	5.5	8.4	9.8	12.9	18.4
Texas	6.8	7.3	7.7	8.6	9.0	12.2
New Jersey	3.1	3.0	4.9	4.3	12.5	14.9
Illinois	4.6	4.4	4.8	4.1	8.3	9.5
Nation	--	--	--	--	7.6	10.4

Source: Center for Immigration Studies (<http://www.cis.org>).

Table 2.4: Illegal Immigrants in the United States, 1996

Country of origin	Population	State of residence	Population
All countries	5,000,000	All states	5,000,000
1. Mexico	2,700,000	1. California	2,000,000
2. El Salvador	335,000	2. Texas	700,000
3. Guatemala	165,000	3. New York	540,000
4. Canada	120,000	4. Florida	350,000
5. Haiti	105,000	5. Illinois	290,000
6. Philippines	95,000	6. New Jersey	135,000
7. Honduras	90,000	7. Arizona	115,000
8. Poland	70,000	8. Massachusetts	85,000
9. Nicaragua	70,000	9. Virginia	55,000
10. Bahamas	70,000	10. Washington	52,000
11. Colombia	65,000	11. Colorado	45,000
12. Ecuador	55,000	12. Maryland	44,000
13. Dom. Republic	50,000	13. Michigan	37,000
14. Trinidad & Tobago	50,000	14. Pennsylvania	37,000
15. Jamaica	50,000	15. New Mexico	37,000
16. Pakistan	41,000	16. Oregon	33,000
17. India	33,000	17. Georgia	32,000
18. Dominica	32,000	18. Dist. of Columbia	30,000
19. Peru	30,000	19. Connecticut	29,000
20. Korea	30,000	20. Nevada	24,000
Other	744,000	Other	330,000

Source: U.S. Immigration and Naturalization Service, <http://www.ins.usdoj.gov>.

Table 2.5: Share of Employment by Occupation, Nationality and Ethnicity, 2000

Occupations	Percent Immigrant	Average Wages	Pct. of Workforce	Pct. Of Immigrants	Pct. of Natives
Total Workforce	12.8	\$33,921	100.0	100.0	100.0
Low-immigrant Occupations	10.4	\$38,616	72.3	58.3	74.3
Managerial and Professional	10.2	\$49,695	31.2	24.8	32.2
Technical, Sales, Admin. Support	9.0	\$30,542	27.9	19.6	29.2
Farming Managers, Forestry, Fishing	8.8	\$12,447	1.1	0.7	1.1
Precision Production, Craft and Repair	14.0	\$30,949	12.1	13.2	11.9
High-immigrant Occupations	19.3	\$21,674	27.7	41.7	25.7
Operations, Fabricators, Laborers	17.6	\$24,319	14.8	20.3	14.0
Service Occupations, Non-household	18.1	\$19,590	11.0	15.5	10.3
Household Service Occupations	39.7	\$12,195	0.4	1.2	0.3
Farming, Except Managerial	40.3	\$13,233	1.5	4.7	1.0

Notes: Data are for persons in the labor force, 16 years and over, employed full time for at least part of the year.

Source: Current Population Survey, March 2000 (<http://www.census.gov/>), Camarota (2001).

Table 2.6: Foreign-Born Share (%) of Industry Employment, 1990

Industry	Education Level			
	Less Than High School	High School Graduate	Some College	College Graduate
All Industry	18.7	5.9	6.3	8.8
Agriculture	31.5	4.2	2.9	2.9
Ag. Services	29.5	9.2	6.4	4.1
Mining	5.8	0.7	3.2	8.1
Construction	18.9	4.7	4.6	9.8
Food Products	33.6	9.1	8.6	7.8
Textiles	13.3	1.9	2.2	6.4
Apparel	41.9	9.7	18.3	25.1
Lumber	9.8	1.5	1.7	4.0
Furniture	24.4	7.6	5.1	5.1
Paper	16.4	3.3	7.4	5.5
Printing	15.7	5.0	5.6	5.5
Chemicals	22.4	4.1	5.7	8.9
Rubber	28.2	5.2	9.4	6.6
Leather	16.0	13.3	10.6	7.5
Stone, Clay, Glass	11.0	4.3	5.6	8.5
Primary Metals	24.1	3.2	3.0	4.1
Metal Products	26.7	7.9	4.9	10.4
Machinery	19.5	4.0	6.3	14.2
Elec. Machinery	24.4	8.6	9.7	13.9
Transport Equip.	18.2	6.0	4.9	6.9
Misc. Manuf.	40.5	9.7	12.9	11.9
Transport., Utilities	11.7	4.0	6.2	8.3
Wholesale Trade	19.7	7.0	6.0	9.3
Retail Trade	15.3	7.0	6.5	11.6
FIRE	15.0	5.7	6.3	8.6
Investment Finance	30.2	10.3	12.0	6.9
Lodging Services	27.8	12.2	13.5	20.5
Personal Services	21.4	9.2	6.1	20.0
Business Services	22.5	7.2	6.4	11.0
Auto. Services	15.6	7.3	12.8	12.3
Repair Services	19.4	1.9	6.9	13.9
Entertainment	12.1	5.6	7.7	5.4
Health Services	12.7	6.1	6.1	13.0
Legal Services	23.3	4.9	7.0	3.7
Educ. Services	10.4	4.7	6.2	6.1
Social Services	9.2	5.3	5.5	6.5
Household Services	32.3	15.5	14.6	26.8
Government	9.7	2.7	4.4	5.1

Source: Public Use Micro Sample (5%), U.S. Census of Population and Housing, 1990.

**Table 3.1: Share of the State Labor Force by Education Category
for Natives and Immigrants, Change 1980-1990**

State	Worker Type	HSDO	HSG	SC	CG
United States	Natives	-7.8	-5.1	6.4	3.9
	Immigrants	0.8	0.2	0.8	0.8
New York	Natives	-6.5	-5.2	4.0	4.3
	Immigrants	0.1	0.4	1.4	1.5
New Jersey	Natives	-7.4	-5.4	4.3	5.2
	Immigrants	0.0	0.4	1.1	1.9
Illinois	Natives	-8.6	-5.8	7.2	5.2
	Immigrants	0.4	0.3	0.7	0.6
Florida	Natives	-6.8	-5.1	5.5	2.9
	Immigrants	1.2	0.3	1.2	0.8
Texas	Natives	-9.7	-3.7	6.2	3.1
	Immigrants	2.1	0.4	0.8	0.8
California	Natives	-5.2	-7.6	1.5	2.4
	Immigrants	3.9	0.9	2.1	1.9
Massachusetts	Natives	-6.2	-6.3	3.8	6.8
	Immigrants	-0.3	0.2	0.8	1.2
Ohio	Natives	-7.4	-4.3	8.1	3.7
	Immigrants	-0.3	-0.2	0.1	0.3
Michigan	Natives	-7.2	-6.0	9.9	3.6
	Immigrants	-0.4	-0.4	0.1	0.3
North Carolina	Natives	-12.9	-1.0	9.2	4.1
	Immigrants	0.1	0.0	0.2	0.3
Georgia	Natives	-11.8	-1.0	6.8	4.4
	Immigrants	0.5	0.2	0.3	0.6
Washington	Natives	-5.2	-7.8	7.6	4.1
	Immigrants	0.4	-0.2	0.5	0.5

Notes: Each cell reports the level change in the share of that state's total labor force accounted for by the factor in that cell. "HSDO" designates high-school dropouts; "HSG" designates high-school graduates; "SC" designates those with some college; and "CG" designates college graduates and beyond.

Table 3.2: U.S. State Labor Supplies, Changes Over 1980-1990

State	HSDO	HSG	SC	CG
United States	-6.9	-4.8	7.1	4.7
Connecticut	-8.2	-4.6	5.3	7.5
Massachusetts	-6.5	-6.2	4.7	8.0
New Jersey	-7.4	-5.0	5.4	7.0
New York	-6.4	-4.8	5.3	5.8
Illinois	-8.3	-5.5	7.9	5.8
Michigan	-7.6	-6.3	10.0	3.9
Ohio	-7.6	-4.5	8.2	4.0
Pennsylvania	-7.9	-4.3	7.0	5.3
Florida	-5.6	-4.8	6.7	3.8
Georgia	-11.3	-0.8	7.1	5.0
North Carolina	-12.8	-1.0	9.3	4.4
Texas	-7.6	-3.3	7.0	3.9
California	-1.3	-6.6	3.6	4.3
Washington	-4.8	-8.0	8.2	4.6

Notes: Each cell reports the level change from 1980 to 1990 in the share of that state's total labor force (employed plus unemployed) accounted for by the factor in that cell. "HSDO" designates high-school dropouts; "HSG" designates high-school graduates; "SC" designates those with some college; and "CG" designates college graduates and beyond.

Source: Hanson and Slaughter (2001).

**Table 3.3: U.S. Labor Supplies in Recent Decades
(% of National Labor Force)**

Year	High-School Dropouts	High-School Graduates	Some College	College Graduates
1940	76	14	5	5
1950	66	21	7	6
1963	52	30	9	9
1970	45	34	10	11
1979	32	37	15	16
1989	23	39	17	21
1999	17	33	25	25

Notes: Each cell reports the percent share of the total U.S. adult population (aged 25 and over) accounted by that labor group in that year.

Source: Johnson (1997, Table 1) for all years but 1999. For 1999, U.S. Bureau of the Census (2000).

Table 3.4: California High-Growth Industries, 1980-1990

Industry Name	Annualized Growth Rate	Skill Intensity	Immigrant Intensity
Machinery	4.32	15	18
Household Services	3.89	40	6
Apparel	3.86	37	1
FIRE	2.76	4	36
Textiles	2.54	29	3
Legal Services	2.32	1	40

Notes: Each industry's output growth rate is the California annualized growth rate less the U.S. annualized growth rate in terms of real value added. The skill-intensity measure reports each industry's ranking among 40 sectors economy-wide, with lower (higher) numbers indicating more skill-intensive (unskill-intensive) sectors. Skill ranks are constructed from the average across 1980 and 1990 of each industry's nationwide employment of college graduates relative to high-school dropouts. The immigrant-intensity measure reports each industry's ranking among 40 sectors in California, with lower (higher) numbers indicating more (less) immigrant-intensive sectors. Immigrant ranks are constructed from the average across 1980 and 1990 of each industry's immigrant share of total employment.

Table 3.5: Explaining California Industry Growth, 1980 to 1990

Regressor	Estimates
Industry Skill Intensity	-0.060 (0.024)
Industry Skill Intensity ²	0.004 (0.002)
Industry Immigrant Intensity	0.382 (0.314)
Constant	0.119 (0.050)
No. Observations	40
Adjusted R-Squared	0.08

Notes: Cell entries are parameter estimates (standard errors) for equation (3.1). Output growth is the California growth rate less the U.S. growth rate. Skill (immigrant) intensity is the average employment of high-school dropouts (immigrants) relative to college graduates (all workers) in 1980 and 1990.

Table 4.1: Illegal Aliens Apprehended by Activity

Year	Mexican Nationals	Of Which		
	Apprehended by U.S. Border Patrol	Working in Agriculture	Working Elsewhere	Seeking Employment
1992	1,168,946	5,488	7,165	1,065,159
1993	1,230,124	5,393	7,403	1,117,414
1994	999,980	5,162	8,068	901,826
1995	1,293,508	4,487	12,552	1,185,761
1996	1,523,141	2,684	9,413	1,405,314
1997	1,387,650	3,521	10,146	1,279,923
1998	1,522,918	3,270	6,616	1,398,892

Source: INS (2000).

Table 4.2: INS Investigations of Employers

Year	Investigations of Employers	Warnings Issued	Notices of Intent to Fine	Sanctions Imposed	Fines Above \$20,000
1992	7,053	840	1,461	777	10
1993	6,237	758	1,302	799	14
1994	6,169	683	1,063	737	13
1995	5,283	550	1,055	792	16
1996	5,149	668	1,019	689	20
1997	7,537	733	862	451	9
1998	7,795	642	1,023	235	9

Source: INS (2000), Employer Sanctions Database (<http://www.cis.org/>).

**Table 5.1: Use of Means-tested Programs
by Head of Household's Nativity, by Year of Entry (%)¹**

Welfare Program	Native Households	Immigrant Households	Pre-1970 Immigrants	1970-79 Immigrants	1980-89 Immigrants	1990-2000 Immigrants
Public Assistance ²	2.1	3.2	1.8	2.9	4.1	3.9
Supplemental Security Income	3.9	5.3	4.9	7.1	5.5	4.1
Food Stamps	5.3	6.7	4.1	6.1	7.5	8.4
Medicaid	12.1	18.6	11.7	17.9	23.5	19.7
Households Using any of the Above	13.3	19.7	21.1	24.3	18.8	12.5
Earned Income Tax Credit	13.1	25.5	10.7	22.9	31.5	32.7

¹ Immigrants and native households defined by nativity of household head. Year of entry based on household head.
² Includes TANF and General Assistance Program.

Source: Camarota (2001), Center for Immigration Studies (<http://www.cis.org>).

Table 5.2:
Use of Means-Tested Programs by Head of Household's Country of Origin, 2000 (%)

Country	Public Assistance	Supplemental Security Income	Food Stamps	Medicaid	Using Any of These	EITC
Mexico	5.5	4.1	10.2	27.2	28.9	49.2
China/Taiwan/HK	0.5	6.5	1.9	12.1	12.6	13.3
Philippines	2.6	8.0	2.2	16.2	16.2	13.2
India	0.5	1.4	0.9	6.6	7.3	10.7
Vietnam	1.1	19.6	15.2	26.6	31.1	21.9
El Salvador	6.1	3.1	8.0	25.6	26.0	48.5
Korea	0.0	4.7	1.6	7.9	7.9	15.0
Dominican Rep.	15.7	16.0	27.5	53.0	54.0	41.8
Cuba	1.5	8.0	14.3	23.3	24.8	17.0
Colombia	0.5	10.4	7.7	25.1	25.1	25.1
Russia	2.5	18.3	15.3	23.8	24.8	7.9
Canada	0.6	1.2	1.2	2.7	3.6	6.0
Jamaica	1.8	5.4	7.1	26.3	26.3	25.4
Haiti	3.0	1.2	5.5	15.9	17.1	38.4
United Kingdom	0.6	0.6	1.2	2.6	2.9	4.3
Guatemala	1.9	3.7	5.6	26.2	26.2	32.7
Peru	2.5	2.5	2.5	20.3	20.3	32.8
Poland	0.0	0.9	0.0	5.1	5.1	9.8
Iran	0.0	8.3	0.0	15.2	15.2	4.5
Ecuador	1.8	7.2	3.6	30.6	32.7	36.9
All Others	2.7	4.3	4.6	13.4	14.4	16.5
All Immigrants	3.2	5.3	6.7	18.6	19.7	25.5
All Natives	2.1	3.9	5.3	12.1	13.3	13.1
Immigrant Avg. Payment Amt. ¹	\$4,673	\$6,369	-	-	-	\$1,692
Native Avg. Payment Amt. ²	\$3,038	\$4,926	-	-	-	\$1,456

¹ Average is for only those who receive payments.
² Average if for only those who receive payments.

Source: Camarota (2001), Center for Immigration Studies (<http://www.cis.org>).

Table 5.3: Overview of Non-Citizen's Benefits Eligibility

	SSI	Food Stamps	Medicaid	TANF	Other Federal Means-Tested Benefits	State/Local Public Benefits
Qualified Immigrants Arriving <i>before</i> August 23, 1996						
Legal Permanent Residents	Yes	No	State option	State option	State option	State option
Asylees, Refugees ^a	Eligible for first 7 years	Eligible for first 5 years	Eligible for first 7 years	Eligible for first 5 years	Eligible for first 5 years	Eligible for first 5 years
Qualified Immigrants Arriving <i>after</i> August 23, 1996						
Legal Permanent Residents	No	No	Barred for first 5 years; state option afterward	Barred for first 5 years; state option afterward	Barred for first 5 years; state option afterward	State option
Asylees, Refugees	Eligible for first 7 years	Eligible for first 5 years	Eligible for first 7 years	Eligible for first 5 years	Eligible for first 5 years	Eligible for first 5 years
Unqualified Immigrants						
Illegal Immigrants	No	No	Emergency services only	No	No ^b	No ^c
PRUCOL Immigrants	No ^d	No	Emergency services only	No	No	No ^c
<p>^a Cuban and Haitian entrants, Amerasians, and aliens granted withholding of deportation are also included in this group.</p> <p>^b States have the option to provide WIC to unqualified immigrants.</p> <p>^c Selected programs are exempted, including short-term non-cash relief, immunizations, testing and treatment for communicable diseases, and selected assistance from community programs.</p> <p>^d Those immigrants receiving SSI as of August 22, 1996, will continue to be eligible until September 30, 1998.</p> <p>PRUCOL= Persons Residing under Cover of Law</p>						

Source: Urban Institute (1997).

Table 5.4:
Immigration's Contribution to the School-Age Population (2000)¹

	School-age (5-17) Pop.		Young Children (0-4)	
	Percent with Immigrant Mothers	Number with Immigrant Mothers (thousands)	Percent with Immigrant Mothers	Number with Immigrant Mothers (thousands)
1. California	43.3	2,939	45.0	1,184
2. New York	27.1	954	27.6	350
3. Florida	28.1	740	22.1	198
4. Texas	22.0	857	23.1	386
5. New Jersey	22.1	323	21.4	113
6. Illinois	15.2	365	18.0	169
7. Massachusetts	17.1	195	12.7	51
8. Arizona	23.1	232	29.9	118
Entire Country	16.3	8,612	17.6	3,456

Source: Camarota (2001), Center for Immigration Studies (<http://www.cis.org>).
¹ Values have been rounded to the nearest thousand.

Table 5.5:
Local, State, and Federal Expenditures, Revenues, and Average Fiscal Balance
by Foreign-Born and Native Households in New Jersey and California
(1996 Dollars)

	New Jersey		California	
	Foreign-Born	Native	Foreign-Born	Native
Expenditures				
Local	4,236	2,969	6,208	5,290
<i>Of which K12 education</i>	2,985	2,162	1,581	768
State	3,146	2,647	4,973	2,510
<i>Of which K12 education</i>	1,878	1,585	2,496	1,212
Federal	-	-	13,326	13,625
Revenues				
Local	3,314	3,113	5,377	5,573
State	2,584	2,735	2,341	3,405
Federal	-	-	10,644	16,347
Fiscal Balance				
Local	-922	144	-831	283
State	-562	88	-2,632	895
Federal	-	-	-2,682	2,722

Note: Figures for New Jersey are for FY 1990, figures for California are for FY 1995. Both are adjusted upward to reflect December 1996 prices. Average fiscal balance equals revenues minus expenditures. If the average fiscal balance is greater than zero, then the average household in this category makes a net contribution.

*The net effect of immigrants on the federal level is available only for California.

Source: Smith and Edmonston (1997).

Table 5.6:
Net Annual Fiscal Impact Imposed by Current Immigrant-Headed Households
on Native Residents in New Jersey and California
(1996 Dollars)

	New Jersey	California
Local	-144	-283
State	-88	-895
Federal	3	4
Total	-299	-1174

Note: Figures for New Jersey are for FY 1990, figures for California are for FY 1995. Both are adjusted upward to reflect December 1996 prices. Average fiscal balance equals revenues minus expenditures. If the average fiscal balance is positive, then the average household in this category makes a net contribution.

Table 5.7:
Average Fiscal Impact of an Immigrant and Descendants by Education Level
(1996 Dollars)

Education Level	Immigrant Only	Immigrant Plus Descendants Over the Next 300 Years*
<High School	-\$89,000	-\$13,000
High School	-\$31,000	\$51,000
>High School	\$105,000	\$198,000
Overall	-\$3,000	\$80,000

* Based on estimated educational transition probabilities

Table 6.1:
Estimated Effect of Increasing Skill Levels
on the Probability of Supporting Immigration Restrictions

Increase Skill Measure by Two Standard Deviations	Year	Change in Probability of Supporting Immigration Restrictions
Occupation Wage	1992	-0.049 (0.021) [-0.083,-0.013]
Education Years		-0.102 (0.020) [-0.133,-0.069]
Occupation Wage	1994	-0.135 (0.022) [-0.171,-0.100]
Education Years		-0.141 (0.022) [-0.175,-0.105]
Occupation Wage	1996	-0.095 (0.023) [-0.133,-0.057]
Education Years		-0.121 (0.025) [-0.162,-0.082]

Notes: Using the ordered probit estimates reported and discussed in the Appendix, we simulated the consequences of changing each skill measure from one standard deviation below its mean to one standard deviation above on the probability of supporting immigration restrictions. The mean effect is reported first, with the standard error of this estimate in parentheses followed by a 90% confidence interval.

Table 6.2:
Estimated Effect of Explanatory Variables
on the Probability that Member of Congress Votes
Against Chrysler Amendment

Increase Variable by Two Standard Deviations	Change in Probability of Voting Against Chrysler Amendment
Percent Immigrant	-0.090 (0.047) [-0.183,-0.026]
Percent Black	-0.127 (0.075) [-0.247,0.002]
Manufacturing Employment	0.018 (0.062) [-0.081,0.115]
Unionization	-0.143 (0.084) [-0.298,-0.030]
Percent Less than H.S.	0.157 (0.063) [0.054,259]
Ideological Conservatism	0.309 (0.048) [0.234,0.388]

Notes: Using the logit estimates reported and discussed in the Appendix, we simulated the consequences of changing each explanatory variable from one standard deviation below its mean to one standard deviation above on the probability of voting against the Chrysler amendment and thus expressing a restrictionist policy preference. The mean effect is reported first, with the standard error of this estimate in parentheses followed by a 90% confidence interval.

**Appendix Table A6.1:
Determinants of Immigration-Policy Preferences**

Regressor	1992		1994		1996	
	Model 1	Model 2	Model 1	Model 2	Model 1	Model 2
Occupation ***	-0.349 (0.130)		-0.811 (0.135)		-0.541 (0.133)	
Education Years		-0.044 (0.010)		-0.074 (0.011)		-0.059 (0.012)
Gender	-0.022 (0.048)	-0.008 (0.046)	0.022 (0.056)	0.083 (0.054)	-0.020 (0.060)	0.024 (0.057)
Age	-0.000 (0.001)	-0.002 (0.001)	0.000 (0.002)	-0.002 (0.002)	0.004 (0.002)	0.002 (0.002)
Race	-0.207 (0.080)	-0.225 (0.080)	-0.222 (0.091)	-0.211 (0.092)	-0.238 (0.096)	-0.241 (0.097)
Hispanic	-0.064 (0.111)	-0.122 (0.110)	-0.306 (0.136)	-0.360 (0.137)	-0.124 (0.120)	-0.172 (0.121)
Immigrant	-0.158 (0.066)	-0.150 (0.066)	-0.213 (0.076)	-0.193 (0.076)	-0.220 (0.087)	-0.207 (0.087)
Party ID	0.003 (0.013)	0.008 (0.013)	-0.006 (0.016)	-0.002 (0.016)	-0.023 (0.016)	-0.016 (0.016)
Ideology	0.057 (0.020)	0.050 (0.020)	0.054 (0.028)	0.041 (0.029)	0.080 (0.025)	0.072 (0.025)
Observations	2485	2485	1795	1795	1714	1714

Notes: These results are multiple-imputation estimates of ordered-probit coefficients based on the 10 imputed data sets for each year. Each cell reports the coefficient estimate and (in parenthesis) its standard error. In both models the dependent variable is individual opinions about whether U.S. policy should increase, decrease, or keep the same the annual number of legal immigrants. This variable is defined such that higher (lower) values indicate more-restrictive (less-restrictive) policy preferences. For brevity, estimated cut points are not reported.

**Appendix Table A6.2:
Determinants of Congressional Immigration Votes**

Regressor	Chrysler Amend.	Educ. Restrctn.	Employ. Restrctn.
Percent Immigrant	-4.057 (1.418)	-8.153 (1.680)	-4.830 (3.534)
Percent Black	-1.732 (1.119)	0.139 (1.116)	1.703 (2.061)
Manufacturing Employment	1.197 (3.840)	-0.223 (5.243)	-13.070 (8.317)
Unionization	-8.715 (2.553)	1.511 (3.321)	16.223 (5.326)
Percent Less than H.S.	6.457 (2.747)	7.516 (3.655)	-1.269 (5.176)
Ideological Conservatism	4.020 (0.480)	7.064 (0.642)	-10.184 (1.461)
Constant	-1.494 (0.541)	-0.302 (0.710)	1.954 (0.904)
Observations	425	433	423

Notes: These results are logit regression coefficients. Each cell reports the coefficient estimate and (in parenthesis) its standard error. The dependent variable is the votes of members of Congress on immigration policy. The variable for each vote is defined such that 1 indicates more-restrictive policy preferences and 0 less restrictive.

Figure 1.1 Share of Foreign Born in U.S. Population

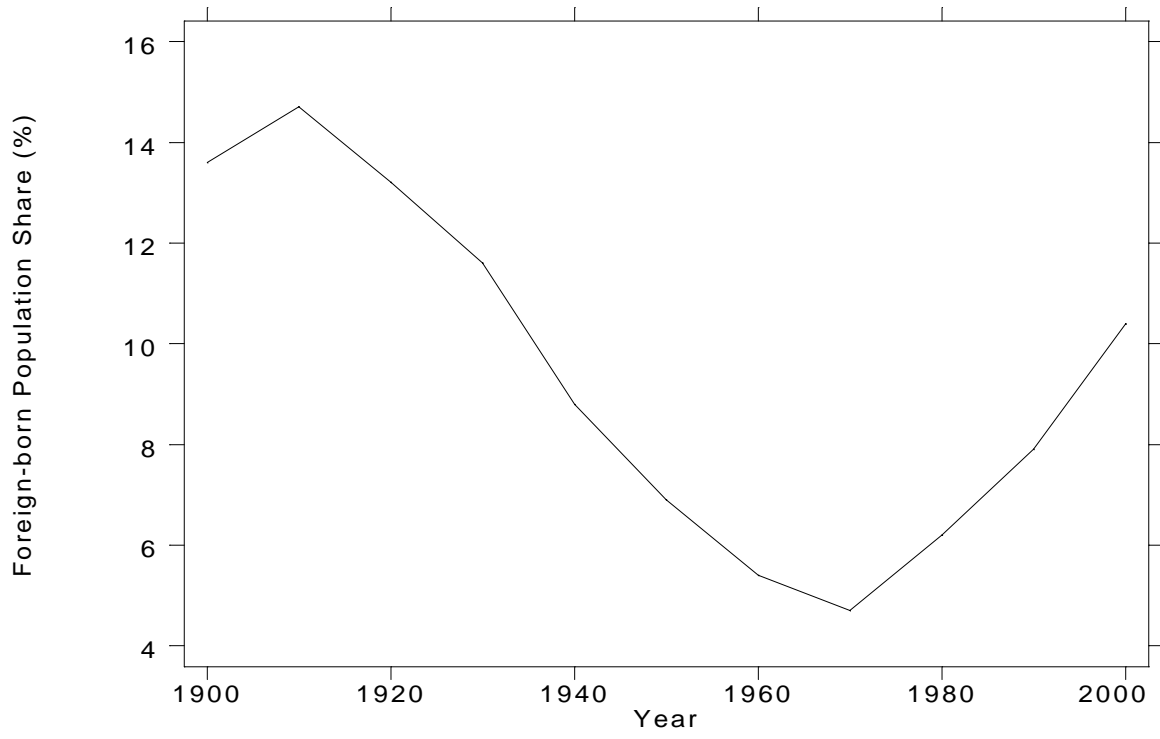

Figure 2.1: U.S. Legal Immigration

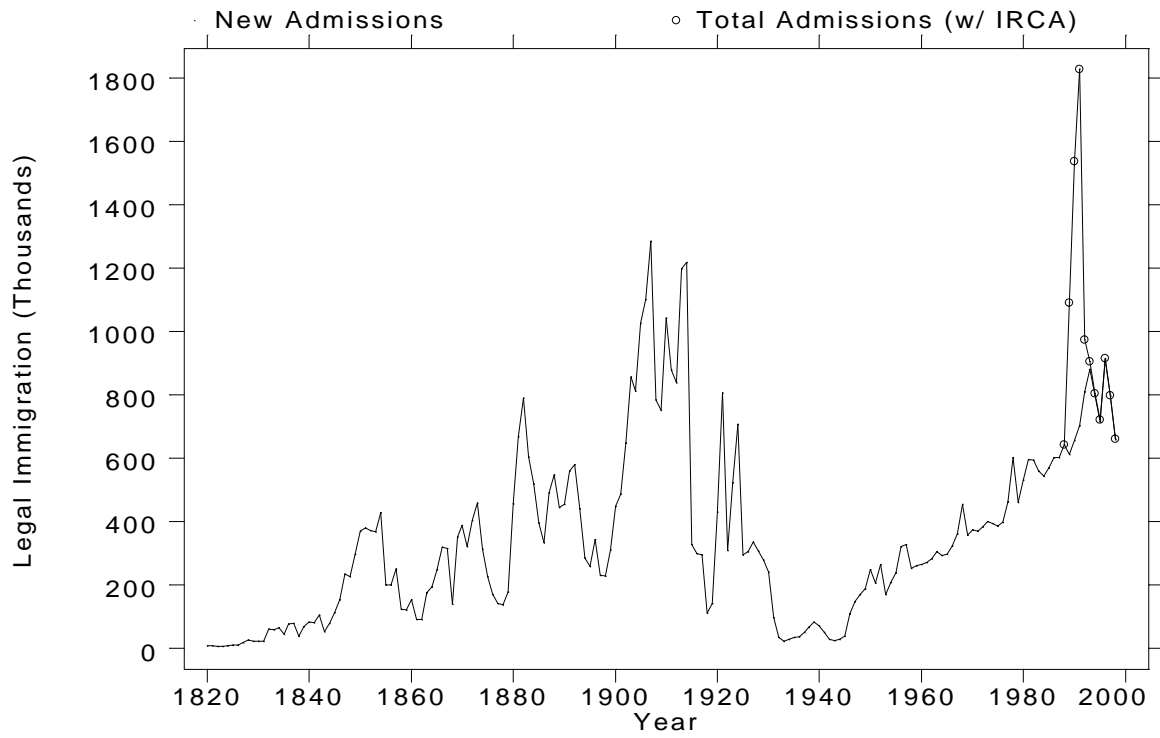
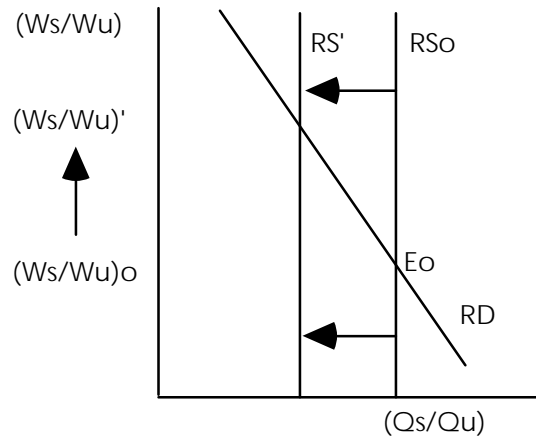
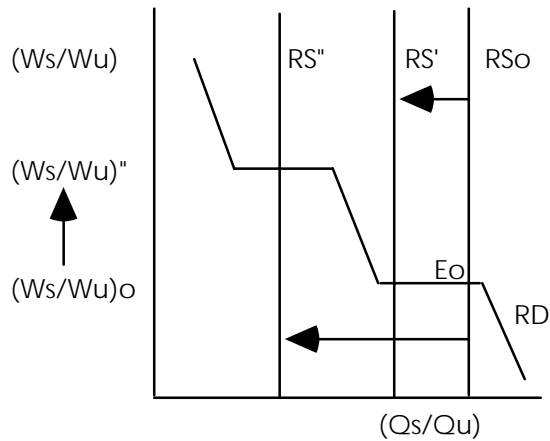

Figure 3.1 Labor-Market Equilibrium: The Area-Analysis Model or The Factor-Proportions-Analysis Model



Notes: Skilled labor is subscripted "s" and unskilled labor "u". The RS schedule is relative supply and the RD schedule is relative demand. For the factor-proportions-analysis model this picture represents the single national labor market; for the area-analysis model this picture represents each separate local labor market.

Figure 3.2 Labor-Market Equilibrium: The Heckscher-Ohlin Model



Notes: Skilled labor is subscripted "s" and unskilled labor "u". The RS schedule is national relative supply and the RD schedule is national relative demand.

Figure 3.3 California Output Growth by Industry Skill and Immigrant Intensity, 1980-1990

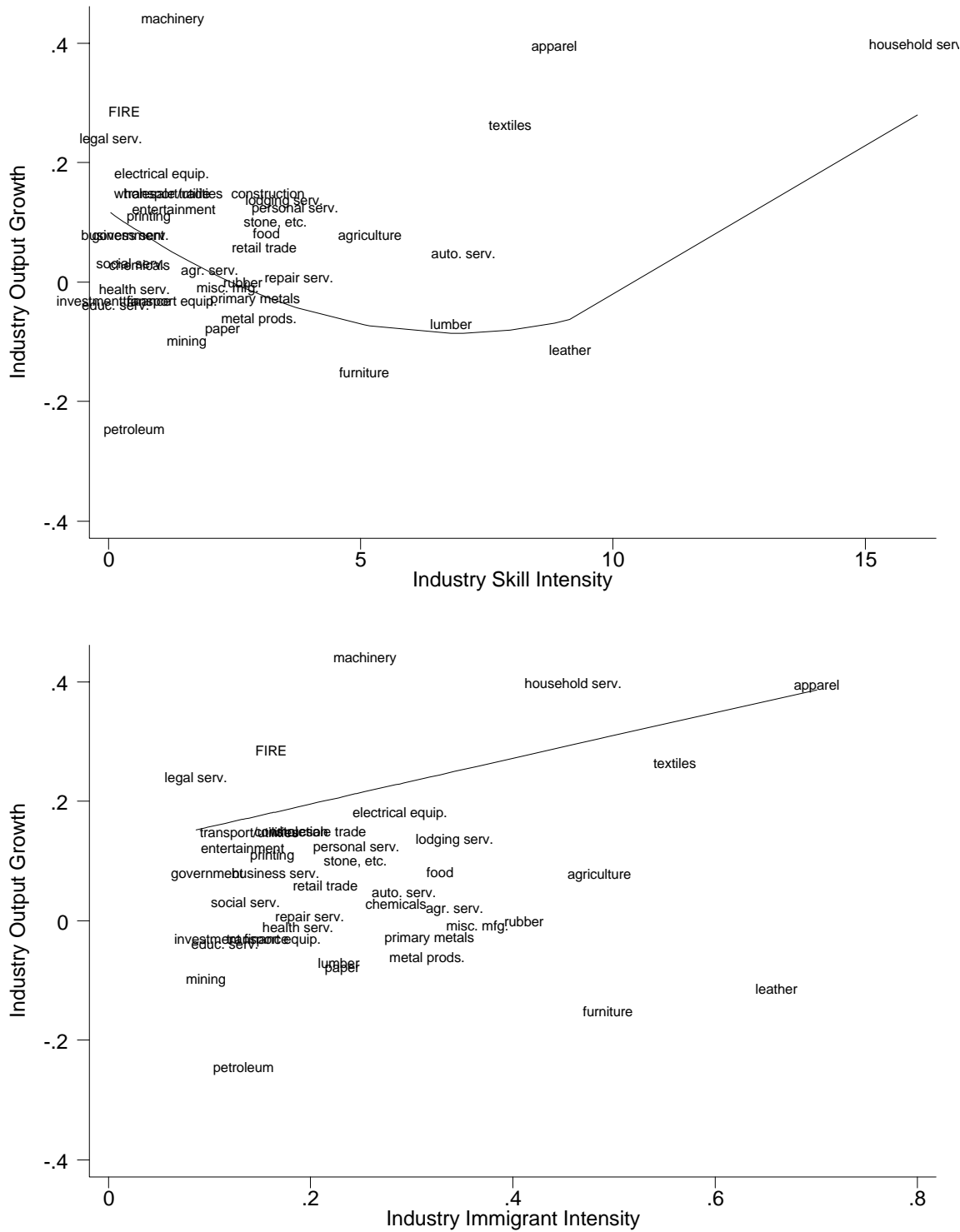

Notes: Industry relative output growth, skill intensity, and immigrant intensity are defined and constructed as in Table 3.5. The curve in each figure is a line of best fit constructed from coefficient estimates in Table 3.5 (see text for details).

Figure 3.4 Level Changes in Industry Employment Shares: California, 1980-1990

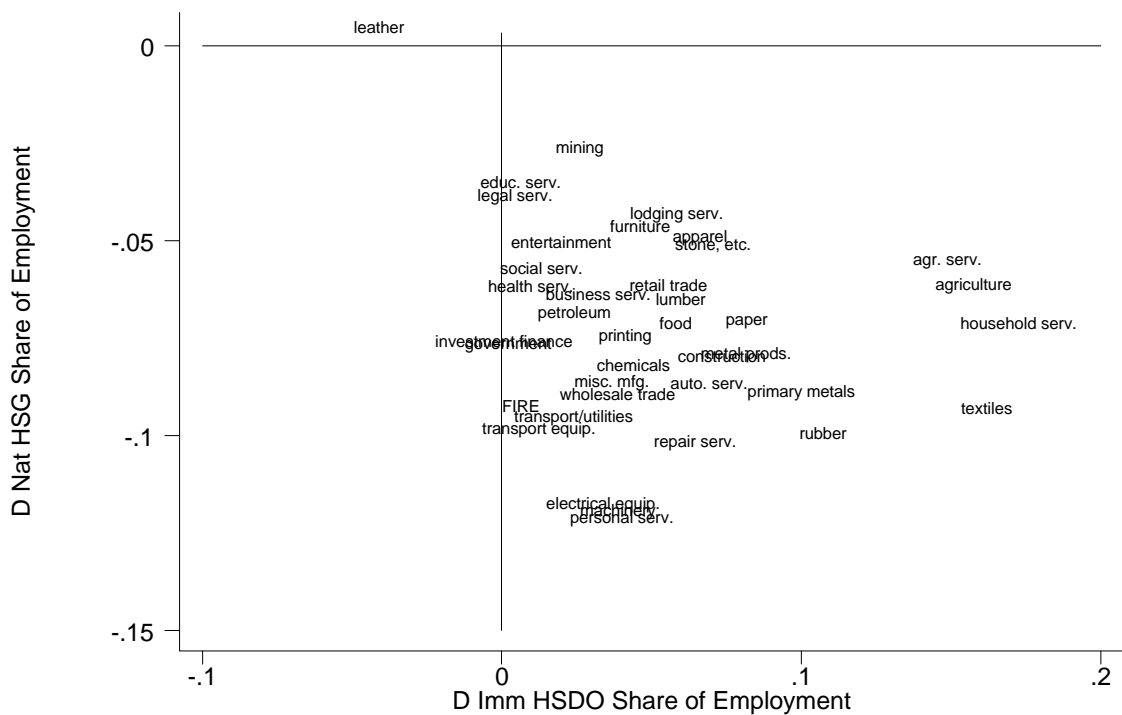
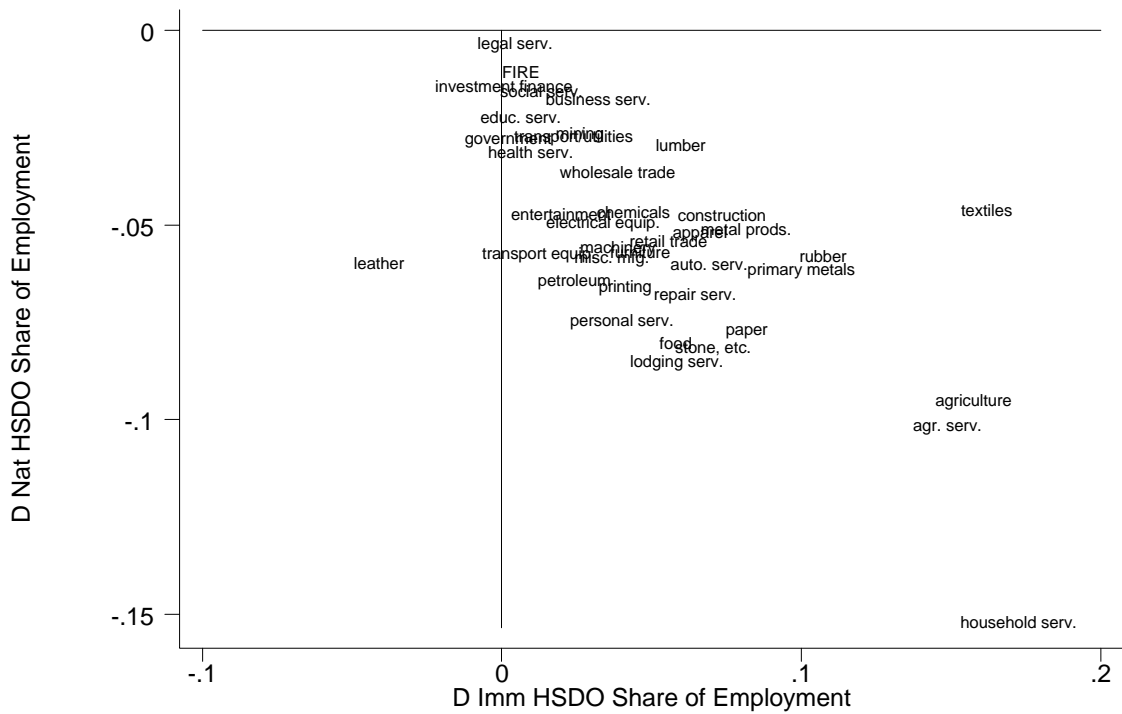

Notes: “D” indicates level changes; “Nat” indicates natives; “Imm” indicates immigrants; “HSDO” indicates high-school dropouts; “HSG” indicates high-school graduates.

Figure 4.1: Temporary Immigration under U.S. Bracero Program, 1942-1964

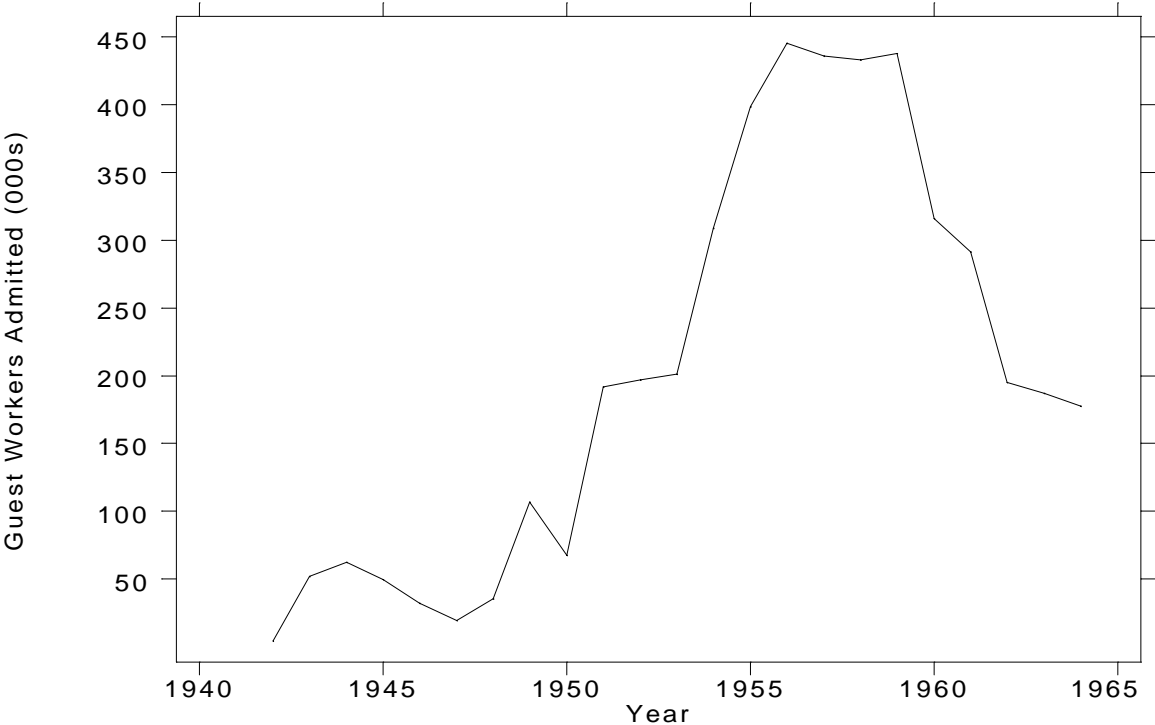

Figure 4.2: Illegal Aliens Apprehended by the INS

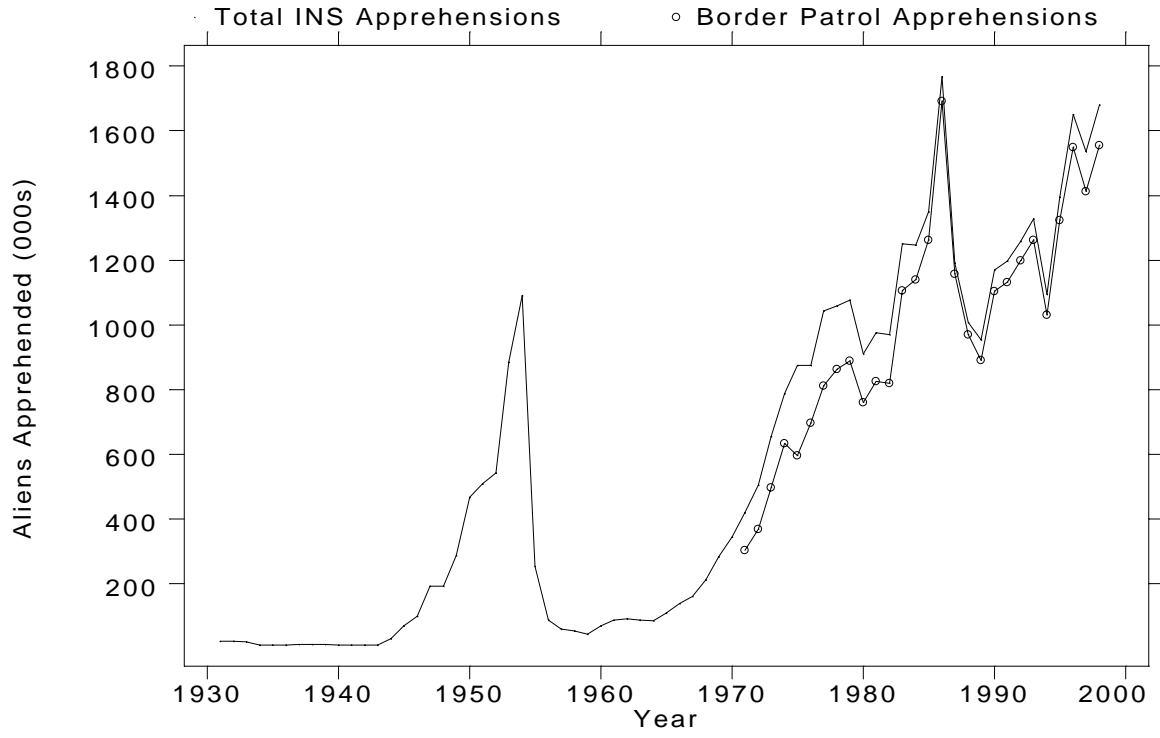

Figure 4.3: Enforcement Budget of the INS

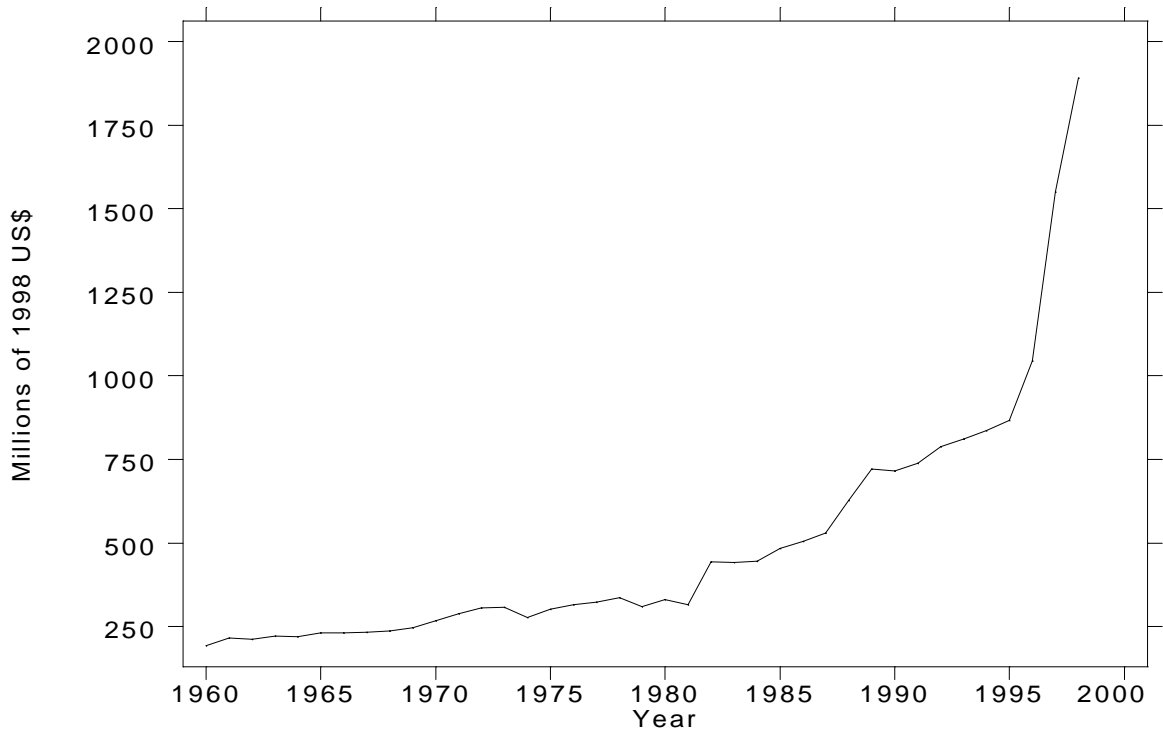

Figure 4.4a: Border Apprehensions by the U.S. Border Patrol

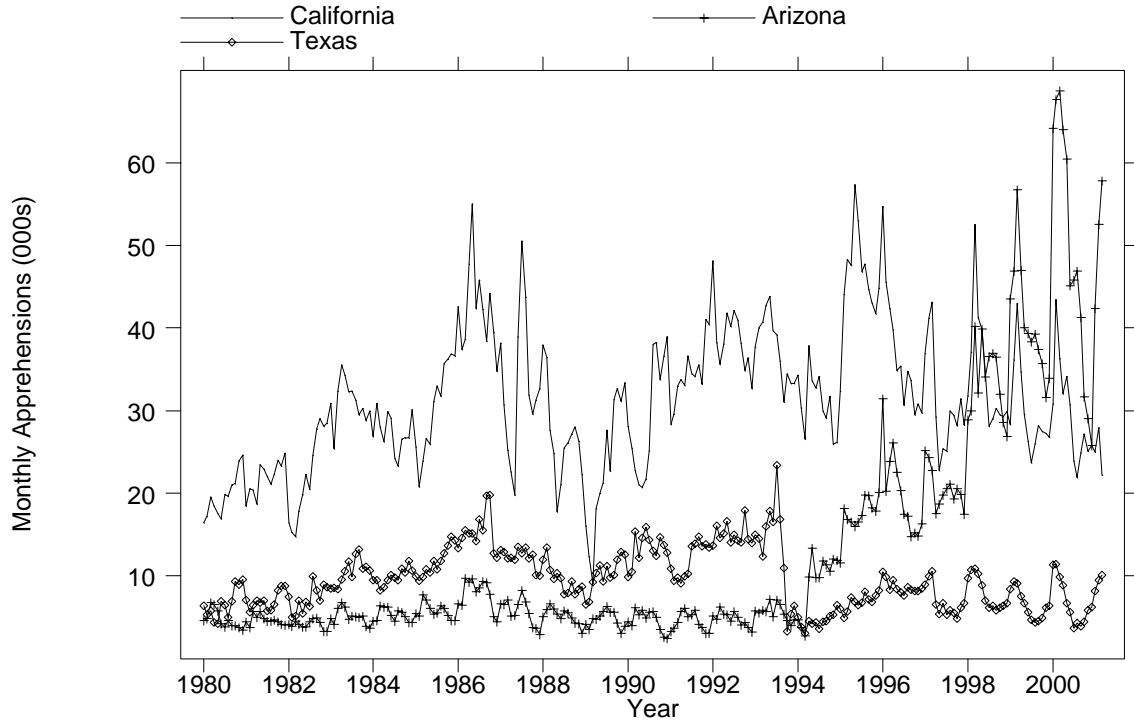

Figure 4.4b: Border Apprehensions at Major Crossing Points

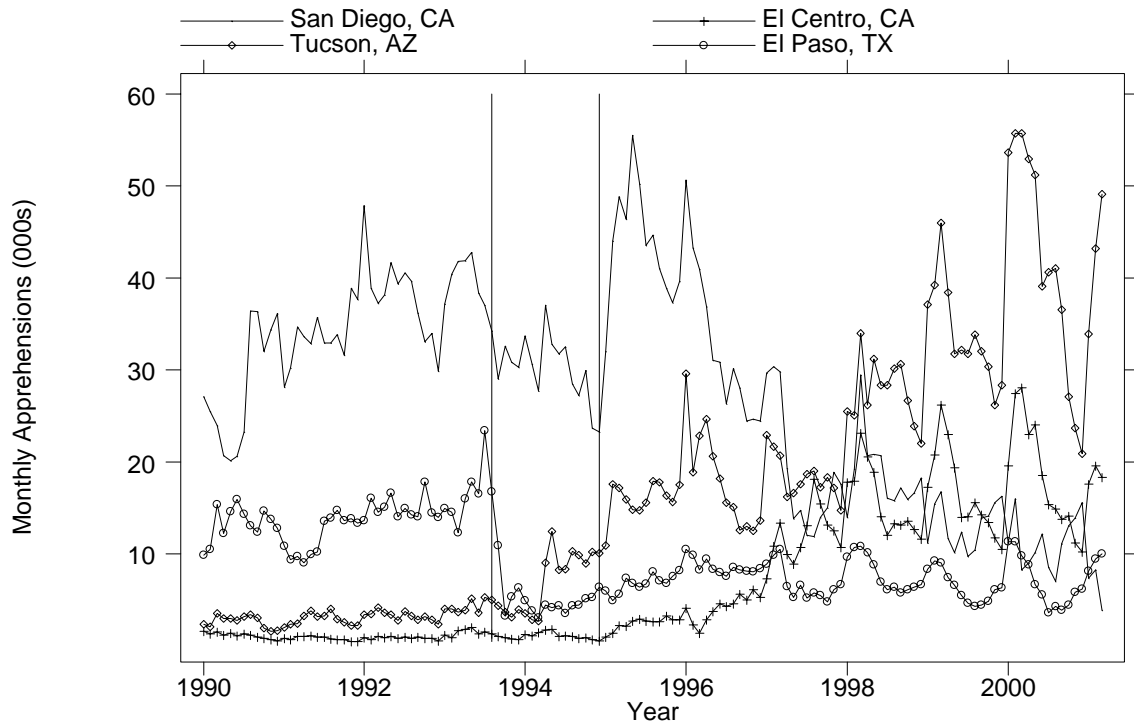

Figure 4.5a: Border Enforcement by the U.S. Border Patrol

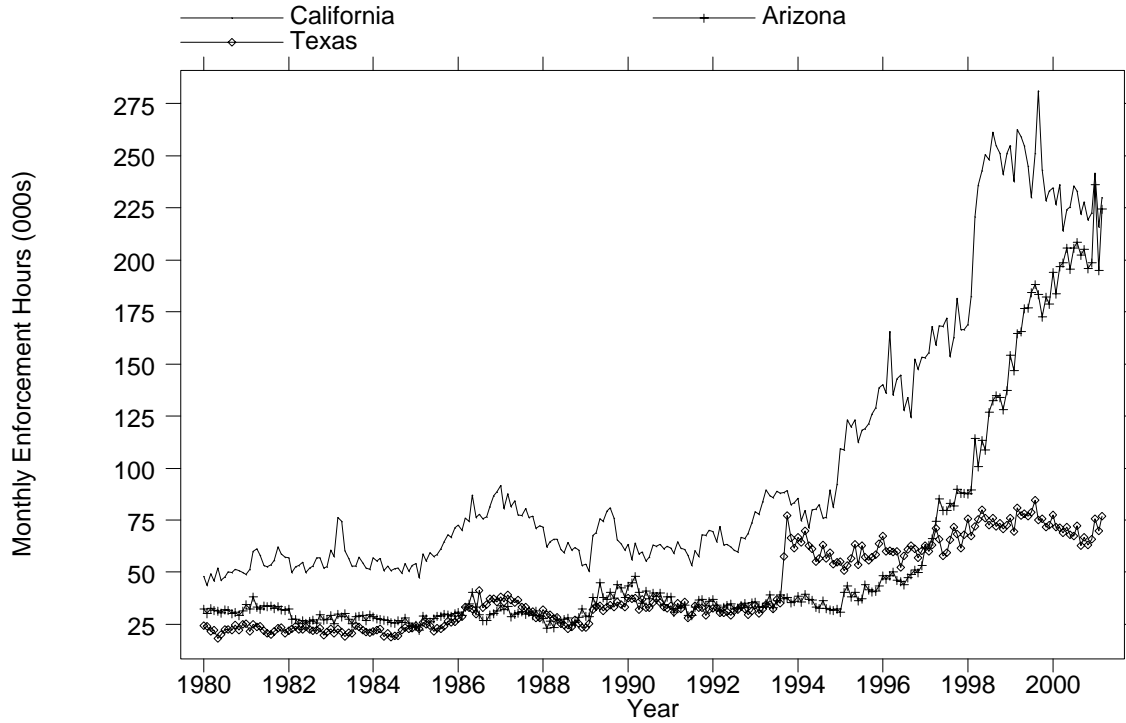

Figure 4.5b: Border Enforcement at Major Crossing Points

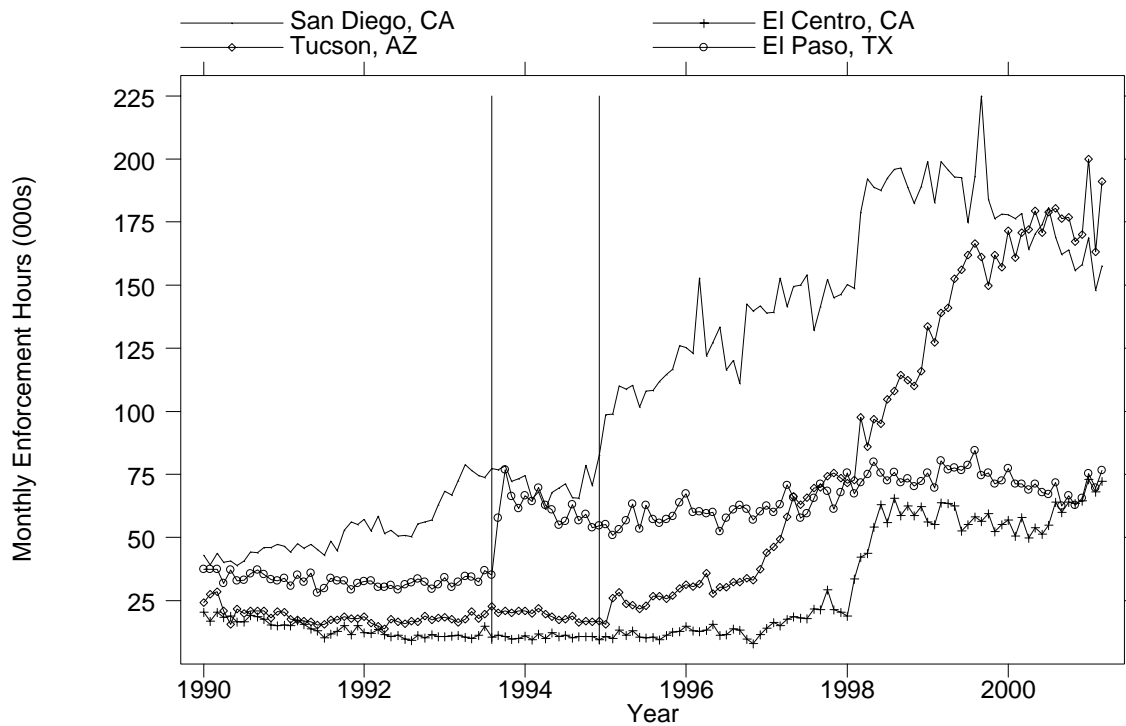

Figure 4.6: Border Apprehensions and Mexican Wages

